



EZ3-TouchPLC Nano Quick Start Guide

EZAutomation

Doc Version 1.0,
08/2019

EZAutomation.net

1-877-774-EASY (3279)

Contents

1	PRODUCT OVERVIEW	4
1.1	FEATURES	4
2	PART NUMBER	5
3	SPECIFICATION	6
4	QUICK-STARTING THE DEVICE	7
5	INSTALLATION	8
5.1	GUIDELINES	8
5.2	MOUNTING INFORMATION	11
5.2.1	<i>Overall Dimension</i>	11
5.3	MOUNTING AND DIMENSIONS	12
5.3.1	<i>Mounting Instructions (6 Inch, 7 Inch Model)</i>	12
5.3.2	<i>Mounting Instructions (8 and 10 Inch Model)</i>	13
6	WIRING	15
6.1	PORTS AND COMMUNICATIONS	15
6.2	NANO PLC - I/O	16
6.2.1	<i>Connection for I/O</i>	16
6.2.2	<i>Terminal Layout</i>	17
6.2.3	<i>Terminal Pinouts</i>	18
6.2.4	<i>Digital I/O Specifications</i>	19
7	PROGRAMMING	21
7.1	PLC OPERATION SEQUENCE	21
7.2	CREATE A PROJECT	22
7.3	TRANSFER A PROJECT	26
8	CPU MEMORY	27
8.1	MEMORY TYPES	27
8.2	MAPPING CONVENTIONS	28
9	ADDITIONAL FEATURES	30
9.1	DATA LOGGING OVERVIEW	30
9.2	CREATE OEM PACKAGER	35
9.3	CREATE USB LOADER	37
9.4	REMOTE MONITORING & CONTROL	39
10	MAINTENANCE AND TROUBLESHOOTING	42
10.1	HARDWARE MAINTENANCE	42
10.2	CHANGING THE BATTERY	43
10.3	UPDATE FIRMWARE	44
10.4	SETUP IP ADDRESS	45
10.5	TROUBLESHOOTING	47

Warnings

Programmable control devices such as the EZ3-TouchPLC Nano units are not fail-safe devices and such as must not be used for stand-alone protection in any application. Unless proper safeguards are used, unwanted start-ups could result in equipment damage or personal injury. The operator must be made aware of this hazard and appropriate precautions must be taken.

In addition, consideration must be given to the use of an emergency stop function that is independent of the EZ3-TouchPLC Nano.

The diagrams and examples in this user manual are included for illustrative purposes only. The manufacturer cannot assume responsibility or liability for actual use based on the diagrams and examples.

Trademarks

This publication may contain references to products produced and/or offered by other companies. The product and company names may be trademarked and the sole property of their respective owners. AVG Automation disclaims any proprietary interest in the marks and names of others.

Manual part number: EZ3-TouchPLC Nano
© Copyright 2019, AVG Automation All Rights Reserved

No part of this document shall be copied, reproduced, or transmitted in any way without the prior written consent of AVG Automation. AVG Automation retains the exclusive rights to all information included in this document.

Designed, Built and Marketed by AVG

4140 Utica Ridge Rd. · Bettendorf, IA 52722-1327

Phone: **1-877-774-EASY** · Fax: **1-877-775-EASY** · www.ezautomation.net

EU Information

The EZ3 Series TouchPLC is manufactured in compliance with European Union (EU) Directives and carries the CE mark. They been tested under CE Test Standard #EN55011, and is submitted for UL Certification. Products with CE marks perform their required functions safely and adhere to relevant standards as specified by EU directives provided they are used according to their intended purpose and that the instructions in this manual are adhered to. The protection provided by the equipment may be impaired if this equipment is not used in accordance with this manual. Only replacement parts supplied by AVG Automation or its agents should be used.

Technical Support

Consult Programming Software Help Directory. You may also find answers to your questions in the operator interface section of our website @ www.ezautomation.net. If you still need assistance, please call our technical support at 1-877-774-EASY or FAX us at 1-877-775-EASY.

SELV Circuits

All electrical circuits connected to the communications port receptacle are rated as Safety Extra Low Voltage (SELV).

Preventative and Maintenance Cleaning

No special preventative measurement is required.

1 Product Overview

Thank You, for using EZ Automation's new line of stunning HMIs that combines our EZ3Touch HMI with PLC capabilities. As the latest in a long line of high performing and easy programming HMIs, the EZ3-TouchPLC Nano is convenient and fast to use. In addition, the EZ3-TouchPLC Nano provides several enhancements over its predecessors including additional communication ports, higher resolution, a standard MicroSD slot, and built in remote monitoring and control features.

This manual presents information on the installation, communication and specifications of the EZ3-TouchPLC Nano. It also covers the troubleshooting and maintenance of an existing setup and provides understanding on how to program the panel with our EZ Editor Software.

1.1 Features

- Available in 6", 7", 8", 10" and 15" models.
- Integrated HMI & Fixed I/O PLC the "Work Horse", 16 DC In, 8 of 10 Amp 1 Form C Relay Outputs makes EZ3 TouchPLC Nano impossible to clone and "PLC is Free".
- DH+ option allows this product to integrate into the AB network.
- The only PLC & HMI with 30+ Exceptionally Innovative and Unique Features and up to 24 Fixed I/O in one package.
- 8 Relay Outputs with 10 Amp 1 Form C, NO and NC contacts with built-in snubbers to extend contact life to 1 million cycles under load.
- Highest Processing power per cubic inch.
- Highest Reliability and Noise Immunity in industry.
- Easiest Integrated HMI and PLC Drag-n-Drop PLC programming software, common to all models.
- Advanced functionalities, PID, Math, High Speed counters.
- Fastest Processing time.
- Status LED for each I/O in every model.
- Patented HMI on-line edit, No downtime.
- All displays are TFT, rated at 400 NITs, 75K hours at 55 degree C.
- Resolution: 6"-320x240, 7"-800 x 480, 8" & 10"-800x600, 15"-1280x768.
- At least 2 for 1 for Unitronics & Maple HMI + PLC, and Cmore/Domore products.
- All models have EZ Wi-Fi option to connect to your laptop without cable.
- Full project simulation on your PC.
- "C" Level scripting and logic expressions.
- Data logging, Recipes, Emails, USBs, free chart recorder.
- On-Screen Recipe Edit.
- Remote Monitoring & Control smart phones & Ethernet.
- Most advanced alarm management.
- Dual Driver capability to communicate to other PLC networks.
- Best looking objects and animation with 65K colors.
- Most Rugged 0.090" thick anti-glare touch screen.
- Unicode for multiple languages.
- Full Project simulation on your PC.
- Unique Visibility tag for best screen space utilization.
- USBs for local data-logging.
- Trending Graphs.

2 Part Number

EZ3 TouchPLC Nano is available in 6, 7, 8, 10 and 15 inch display sizes; with 24 I/O configuration.

EZ3-TxC-xx-Nano-PLC

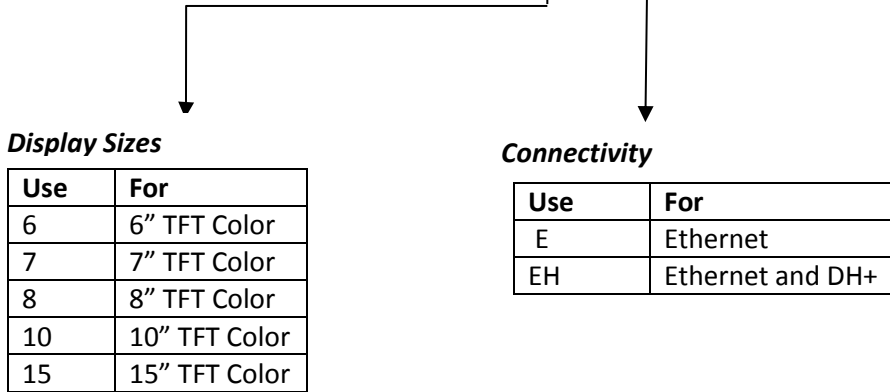

Programming software and cable

- EZTOUCH-EDITOR** TOUCHPLC Editor runs on windows 7 or higher (common to all EZTOUCHPLC models)
- EZ-PGMCBL** Serial cable for PC to TOUCHPLC connection

3 Specification

EZ3TouchPLC Nano with DH+ option for 6", 7", 8", 10" and 15"					
Part Number	EZ3-T6C-EH-Nano-PLC	EZ3-T7C-E-Nano-PLC	EZ3-T8C-E-Nano-PLC EZ3-T8C-EH-Nano-PLC	EZ3-T10C-E-Nano-PLC EZ3-T10C-EH-Nano-PLC	EZ3-T15C-E-Nano-PLC EZ3-T15C-EH-Nano-PLC
Digital Inputs	16 Inputs				
Relay Outputs	8 Relay Outputs (1 Form C Relays rated at 10 Amps each with RC Snubber Protection). 1 million cycles.				
High Speed Counter	2 Inputs can be configured as 2 x 32 bit Up counter, or 1 x 32 bit Up-Down counter, or 1 x 32 bit Quadrature Encoder 20 KHz				
Display Type	5.7" TFT (65K Colors)	7" TFT (65K Colors)	8" TFT (65K Colors)	10.4" TFT (65K Colors)	15.0" TFT w/Built-in Anti-glare
Brightness/Life	400 nits / 75,000 hours@55 °C				
Screen Resolution	320 x 240	800 x 480	800 x 600		1024 x 768
Touch Screen	5-wire Analog Resistive Touch Screen				
Num of Display Screens	Up to 999 Limited by display memory				
Display Screen Saver	Yes, Backlight Off				
HMI User Memory	4MB Built-in Flash Memory (Note Due to how HMI memory is consumed in the EZTouch Hardware this is sufficient for 99% of applications)				16 GB SSD
Maximum I/O Capacity	24 I/O				
Maximum Power Consumption	25 Watts @ 24VDC		30 Watts @ 24VDC		40 Watts Max
Processors	Two 32 Bit, 40 MHz RISC Processors (One for PLC and One for HMI)				
Total PLC Memory	64 KB (Ladder)				
# of PLC Registers	8192 16Bit, 8192 Variables				
PLC Typical Scan Time	3ms (1K Boolean)				
Real Time Clock/Cal.	No PLC Real-time Clock, HMI has RTC				
Battery Backup	Yes (Required only for Real Time Clock as everything else is stored in Flash)				
PLC LED Indicators	Input Power, CPU Status				
I/O Supported	Fixed I/O with Status LEDs				
Electrical Noise	Nema ICS 2-230 Showering arc; ANSI C37.90a SWC; Level C Chattering Relay Test				
Withstand Voltage	1000VDC (1 minute between power supply input terminal and protective ground)				
Insulation Resistance	Over 20M Ohm between power supply input and terminal and protective ground				
Enclosure	Nema 4, 4x (indoor)				
Operating Temperature	0 to 55°C (32 to 131°F)				
Storage Temperature	-25 to 65°C (-13 to 149°F)				
Vibration	5 to 55Hz 2G's for 2 hours in X,Y, and Z axis				
Shock	10G for under 12ms in the X,Y, and Z axis				
Humidity	10-95% Non-Condensing				
USB & microSD port	1 USB port for programming, 1 USB port for Datalogging and 1 microSD slot for additional data storage				
Communication Ports	Built-in USB, RS232/RS485, Ethernet, and Micro SD card Ports				
Agency Approval	UL, CUL, CE				
External Dimensions	8.048" x 6.146" x 4.325" (204.41 x 156.11 x 109.87mm)		10.894" x 8.748" x 4.363" (276.71 x 222.20 x 110.82mm)		13.584"x10.594"x 4.299" (34 5x 269.1 x 109.20mm)
Weight	3 lbs		5 lbs		7 lbs
					12 lbs

4 Quick-starting the Device

This section outlines the steps needed to setup the EZ3-TouchPLC Nano and get it started. This is not intended to explain specific details needed to start your system. Rather, it provides a quick guide to give a broad picture of what is needed to power-up EZ3-TouchPLC Nano system.

It is always recommended to make sure you have all the right parts to build your system. This is what you will need to get started:

- EZ3-TouchPLC Nano unit
- USB Programming cable*
- 2.5mm blade screwdriver for I/O wiring (P/N EZIO-SCDRV)*
- Programming Software: EZ Series Editor Programming Software*
- 24VDC Power Supply*

** These accessories have to be purchased separately*

Step 1: (Optional) Wire Input / Outputs

You may wire required inputs and outputs now or later. Using the 2.5mm blade screwdriver, simply insert the wire and screw to tighten. Please refer to the [wiring section](#) for information on connecting the Input/Outputs to the EZ3-TouchPLC Nano terminals.

Step 2: Connect Power

Connect the power input wires to the EZ3-TouchPLC Nano power terminals as outlined in the [Powering the EZ3-TouchPLC Nano](#) section. Supply 24VDC nominal (20-28VDC) power to the system. Ensure the indicator LED located on the PLC base is ON (green LED). If not, remove power from the system and check all the wiring.

Step 3: Create a Project

Open Touch Panel Editor and create HMI screen and Ladder Logic. The EZTouch Editor Software Manual explains the programming instructions in detail. A sample project is outlined in the [Programing Section](#).

Step 4: Transfer Project to Unit

The project can be transferred to the unit either serially or through the Ethernet port. If connecting through the USB programming cable, ensure the cable is connect to the unit and PC running the Editing Software. Then using the Software, select **File > Transfer to Panel**. Under the dialog window select the appropriate COM port that the USB is connected with and then click Start.

5 Installation

5.1 Guidelines

Safety Considerations

Please follow all applicable local and national codes to ensure maximum safety of the equipment and personnel. The installation and operational environment must be maintained per the latest revision of these codes.

You are responsible to determine the codes to be followed and to verify the compliance of equipment, installation, and operation with the latest revision of these codes.

It is an absolute must to follow all applicable sections of:

- The National Fire Code
- The National Electrical Code (NEC)
- The National Electrical Manufacturer's Association (NEMA) codes

Safety Guidelines

Safety is the most important element of a proper system installation. Adhering to these safety considerations ensures the safety of yourself and others, as well as the condition of your equipment. We recommend reviewing the following safety guidelines:

1) *Disconnecting Main Power*

The main power switch should be easily accessible to the operators and maintenance personnel. It is important to make sure that all other sources of power including pneumatic and hydraulic are de-energized before starting the work on a machine or process controlled by an EZ3 Series TOUCHPLC.

2) *Safety Circuits*

Most of the machines are installed with safety circuits such as limit switches, emergency stop push buttons, and interlocks. These circuits should always be hardwired directly to the EZ3 Series TOUCHPLC. These devices must be wired in series so that when any one device opens, the PLC is automatically de-energized. This removes power to the machine. These circuits should not be altered in any case, since this could result in serious injury or damage to the machine.

3) *Fail-Safe Operation*

Our products are not fault-tolerant. They are not designed or intended for use as online control equipment in hazardous environments requiring fail-safe performance, such as in operation of nuclear facilities, aircraft navigation or communication systems, air traffic control, direct life-support machines, weapons systems, clutch control systems on presses, in which the failure of the product could lead directly to death, personal injury or severe physical or environmental damage. External fail-safe and/or redundant components are required to make your control system fail-safe.

Installation Considerations

Our products have been designed and tested for operation in the most demanding industrial environments. Modern solid-state industrial controls are complex electronic equipment that operate at low levels of voltage and current, co-existing with components that operate at much higher levels of power. The difference in operating power characteristics between the high and low power control devices creates the possibility of unwanted signals being generated, thus causing interference. The interference, which is a by-product of electrical noise, is not present at all times. However, if it appears at random and for brief periods of time, it can cause disruptions and errors in the operation of a control system.

Enhancement of a system's noise level immunity and its tolerance to other environmental hazards can be accomplished by following proper system installation guidelines. The recommendations are of a general nature and constitute good industrial installation practice.

General Environmental Considerations

Avoid installing EZ3 Series TouchPLC in areas where the following conditions may exist:

- Environmental temperatures above or below those specified by the EZ3 Series TouchPLC
- Prolonged exposure to humidity and liquids which may be sprayed or splashed on the equipment
- Dusty environments where airborne particles may accumulate on equipment causing reduction of heat dissipation and reduction in effective electrical spacing between components
- Areas with excessive vibration
- Areas with high-radiated electrical noise, such as near fields of transmitting antennas and areas in close proximity of arc welding stations

Physical Layout in a Control Cabinet

When possible, cabinets housing electronic equipment should be designed with provisions for natural or forced ventilation to facilitate heat dissipation. Observe the following rules for cabinet installation:

- Heat generating equipment (power supplies and other heat inducing components) should be installed toward the top of the cabinet. The lower space in the cabinet is cooler than the top area.
- Install heat-sensitive components in the lower section.
- Provide enough space between components to allow a free flow of air for better heat dissipation.
- Provide the maximum possible physical separation between solid state and electromechanical controls. If possible, the electromechanical controls (motors, starters, solenoids, etc.) should be housed separately or at the farthest point when enclosed within the cabinet.
- We recommend that the EZ3 Series TOUCHPLC have a minimum clear space of 2" on all sides for adequate ventilation as shown in the image on the left.

Electrical Considerations

This section is designed to provide you with a very basic understanding of electrical noise and how to keep it away from CPUs. Industrial plants have a number of generators of electrical noise that are sometimes also referred to as Radio Frequency Interference (RFI). Anytime an inductive load like a motor, motor starter, or solenoid is turned off, it generates a burst of excess energy that has to flow back to ground, just like electrical energy from a lightning storm has to flow back to Earth. RFI is short bursts of electrical energy at very high frequencies. Other sources include RF Welders or Radio Transmitters.

Effect of RFI on Electronic Automation Equipment

Electronic controls use faster and faster CPUs today. These CPUs are also operating at 2.5V to 5VDC logic level power supply. RFI, if allowed to enter the CPU inside, is a killer of logic. A CPU under this environment loses its brain and behaves erratically. A smart industrial-grade CPU like the EZ3 Series TOUCHPLC Card Engine, when faced with RFI, halts its operation instead of giving false outputs.

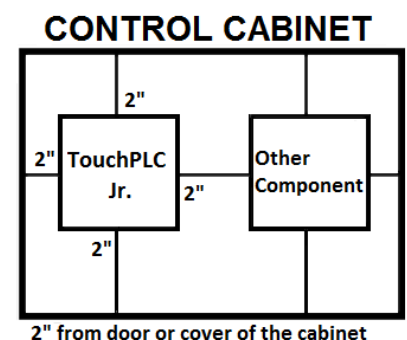

Types of RFI

RFI enters electronic controls in two ways: radiated RFI or conducted RFI. For most practical purposes, electronic devices, unless sitting right next to a powerful RFI transmitter, will not be affected by noise because air space severely attenuates such interference. On the other hand, conducted RFI travels over conductive surfaces such as power supply wires, electrical wiring of field devices, and worst of all; improper ground planes.

Equipment cabinets usually incorporate one or two doors and/or hinged cabinet panels. Relying on door hinges and swinging panels for a good metallic bond between hinged parts and the main body of the cabinet does not insure adequate grounding. Instead, the use of ground straps is recommended. It is vital for the reliable operation of any electronic device to have any of its metallic surfaces well ground to Earth. This not only provides for safe operation, it will also drain out any conducted RFI to Earth, away from the CPU's signal ground.

Shielding from RFI

Shielded Cables

Power cables, I/O cables or wiring, and communication cables should all be separate so that they do not couple the conducted RFI on any of these wires/cables. Another path for RFI into the PLC is through its RS232 port. Hence, the cables to this port must be shielded properly.

Equipment Cabinets

As mentioned, equipment cabinets typically incorporate one or two doors and/or hinged cabinet panels. In addition, sub-panels may be utilized on those electronic controls and electromechanical items that are mounted. The goal is to create a medium for mounting the equipment and ensure grounding of the control's chassis to it. However, the door hinges and swinging panels by themselves are not enough to ensure adequate grounding.

Similarly, the equipment enclosures are generally either painted or anodized. Mounting of painted or anodized enclosures to like surfaces also does not ensure good metallic contact between the equipment chassis and cabinet. It is imperative that the equipment chassis are grounded such as through the use of grounding straps as illustrated below.

Cabinet Wiring

The wiring of the EZ3 Series TOUCHPLC to the "field" outside the cabinet must be by design. The wiring cannot be random in order to get the various points of the cabinet and the "field" electrically connected. Below are some general rules that apply in most situations: Provide a separate power source to electronic controls and keep this power bus away from any I/O power.

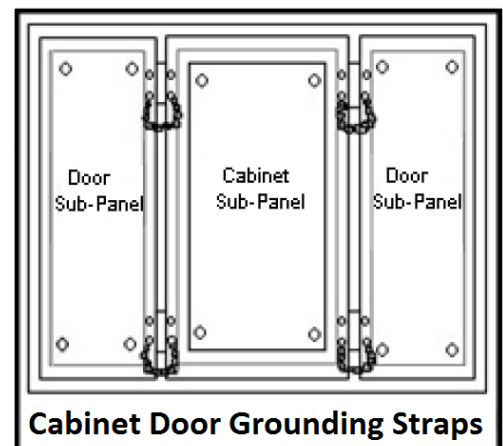

The cabinet should be wired with a safety ground (the main safety ground wire gauge is determined by the cabinet's total current consumption) and in accordance with all electrical code requirements. Once the cabinet doors, stationary sub-panels and swing-out sub-panels have been "strapped" to the main cabinet, it is not necessary to run safety ground wires from the equipment chassis terminals to the main safety ground connection.

The safety ground terminal of each component can, and should be, connected with the shortest wire possible, to the cabinet or sub-panel frame. Plan the wiring routing. Keep all switched power in separate ducts and if there is AC and DC power being switched, keep the wiring of each branch separate from all wires and cables carrying low level signals.

Keep all three phase power outside of the cabinet, but if it becomes necessary, keep the runs as short as possible and maintain the maximum possible distance between the three phase bus and all other wiring.

Primary power leads to the control equipment (Base power terminals) should be made with a two wire twisted cable with approximately 12 turns per foot. The length of these cables should be kept to a minimum, and to the greatest extent possible, such cable runs should be kept separate from other wiring.

5.2 Mounting Information

- EZ3-TouchPLC **6 Inch and 7 inch** model mounting is based on **Din Clips**.
- EZ3-TouchPLC **8 Inch and 10 Inch** model mounting is based on **Studs Dimension** see below in Section [5.3.2](#).

5.2.1 Overall Dimension

Units: inches [millimeters]

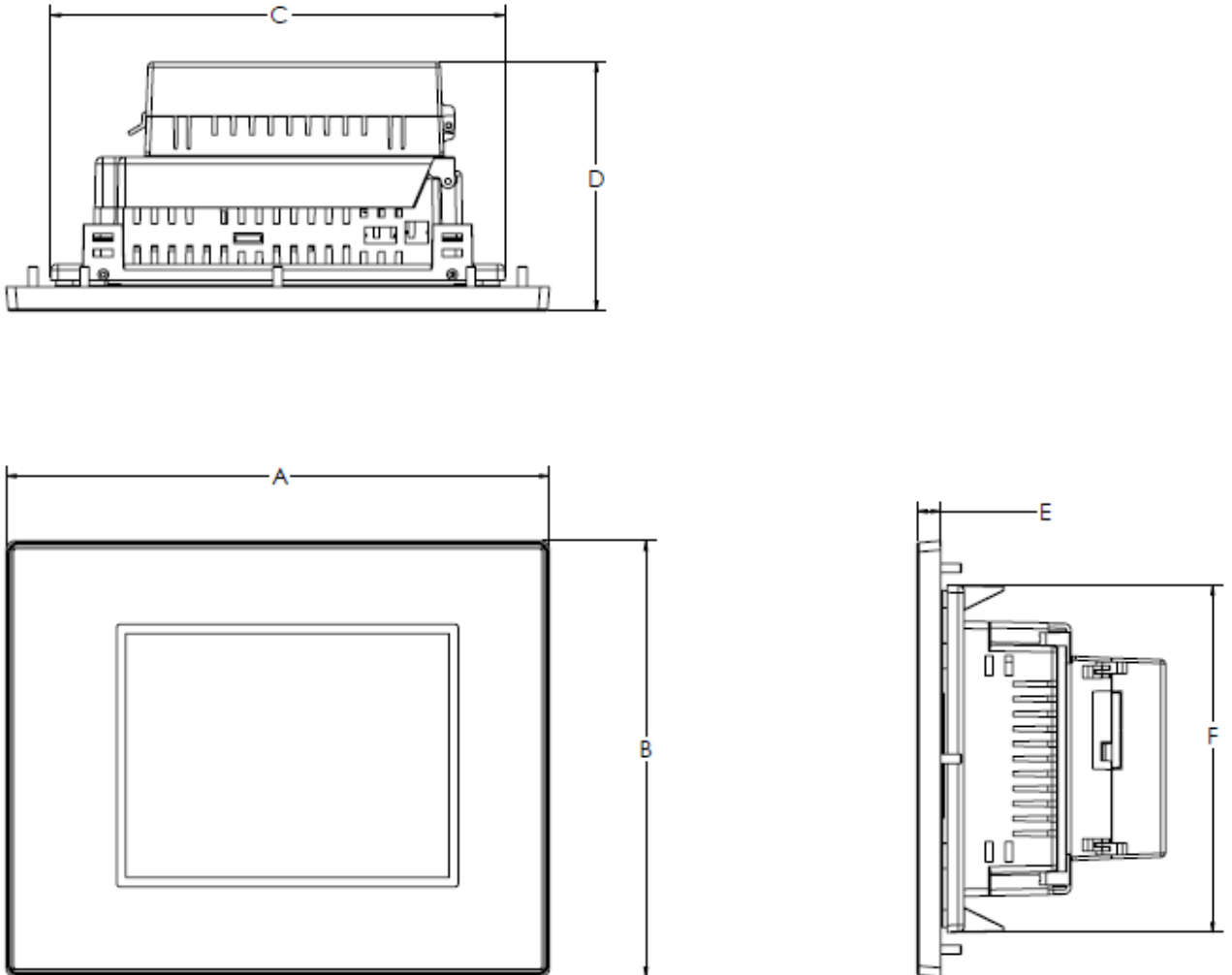

Unit Size	A	B	C	D	E	F
6"	8.05" [204.42]	6.15" [156.11]	7.42" [188.34]	4.37" [110.93]	0.25" [6.35]	5.51" [140.06]
7"	8.05" [204.42]	6.15" [156.11]	7.42" [188.34]	4.37" [110.93]	0.25" [6.35]	5.51" [140.06]
8"	10.89" [276.7]	8.75" [222.2]	9.11" [231.4]	4.98" [126.5]	0.47" [12]	6.96" [176.9]
10"	13.58" [345]	10.59" [269]	11.79" [299.4]	4.98" [126.5]	0.47" [12]	8.81" [223.8]
15"	16.75" [425.5]	13.00" [330.2]	14.83" [376.8]	6.62" [168.2]	0.38" [9.5]	11.18" [284]

5.3 Mounting and Dimensions

5.3.1 Mounting Instructions (6 Inch, 7 Inch Model)

The 6-inch and 7-inch models (6" EZ3-TouchPLC Nano, 7" EZ3-TouchPLC Nano) must be mounted using DIN Clips. DIN Clips are metal brackets (P/N EZ- BRK-1, package of 2 brackets and 4 screws) that attach to the panel and secure the front panel to a mounting surface with 4 screws. Use the diagram and instructions below to mount the EZ3-TouchPLC Nano unit using DIN Clips.

1. There are 4 rectangular holes in each side (two at the top and two at the bottom) of the chassis as shown in the following figure. Choose the holes that allow the appropriate space for your mounting panel thickness.
2. On each DIN Clip there are two metal tabs (bent inward) that fit into these holes. Insert the two clip tabs into two holes (top and bottom) and secure the panel by alternately tightening the DIN Clip screws (4) until the back edge of the unit's front plate is flush with the mounting panel.

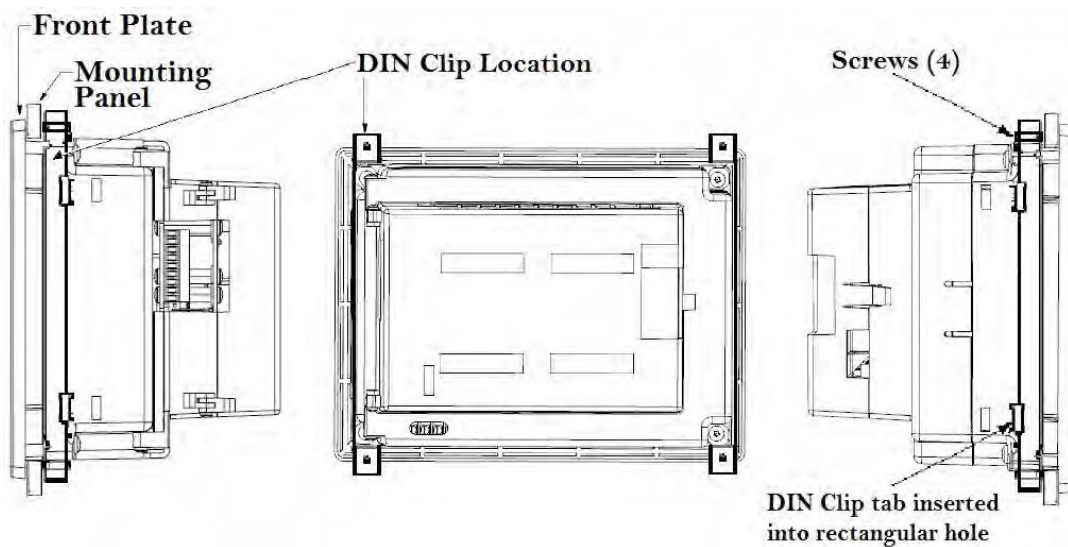

5.3.2 Mounting Instructions (8 and 10 Inch Model)

The 8" and 10" EZ3-TouchPLC Nano units are stud mounted. All the necessary mounting hardware is provided with the unit. Use the 8 studs and 8 nuts with captive washers to secure the unit to the mounting surface.

Note: Nuts are to be tightened with no more than 1 inch-pound of torque.

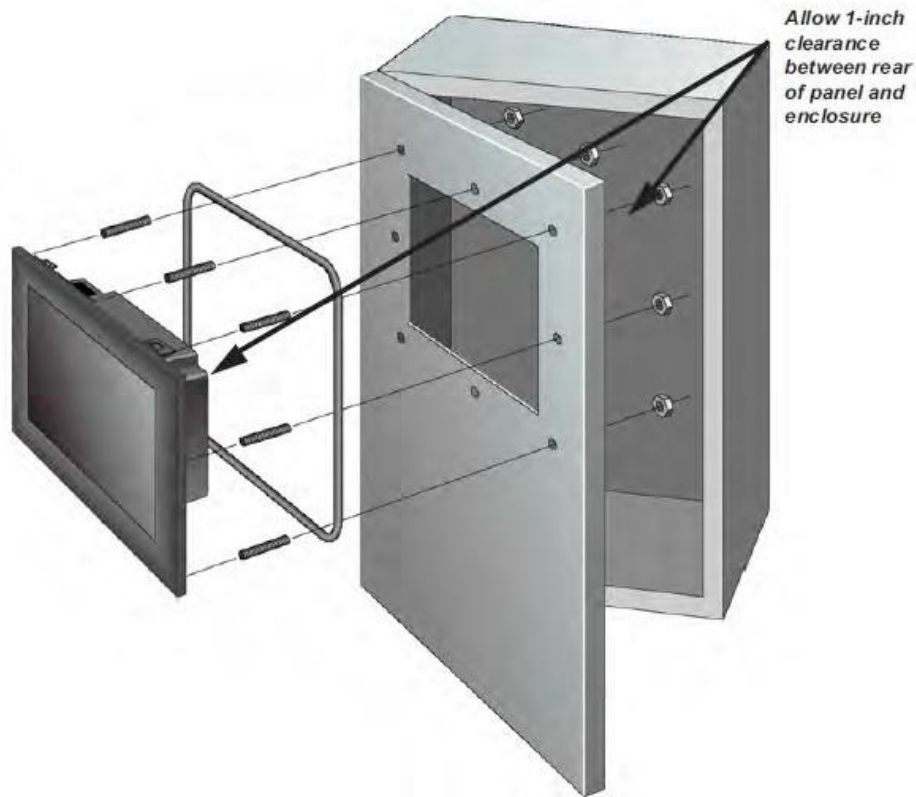

T8C (8" Display) Mounting Dimension:

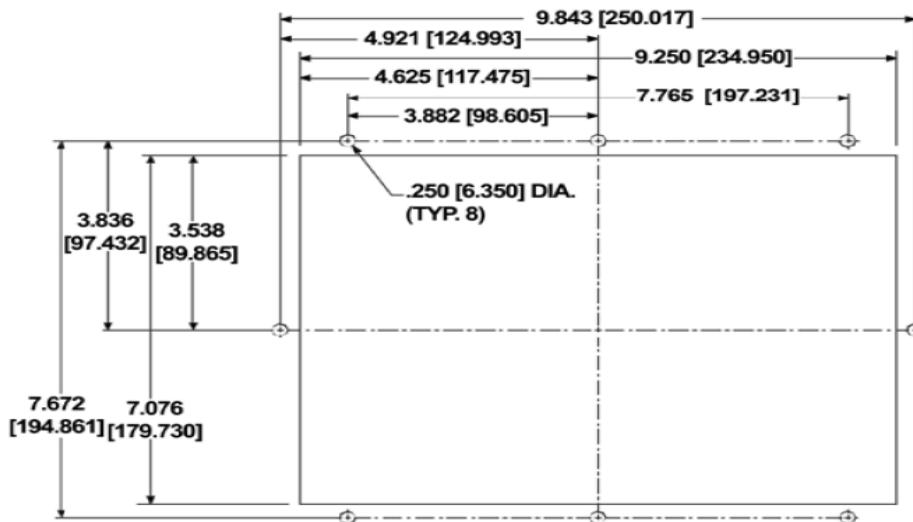

T10C (10" Display) Mounting Dimension:

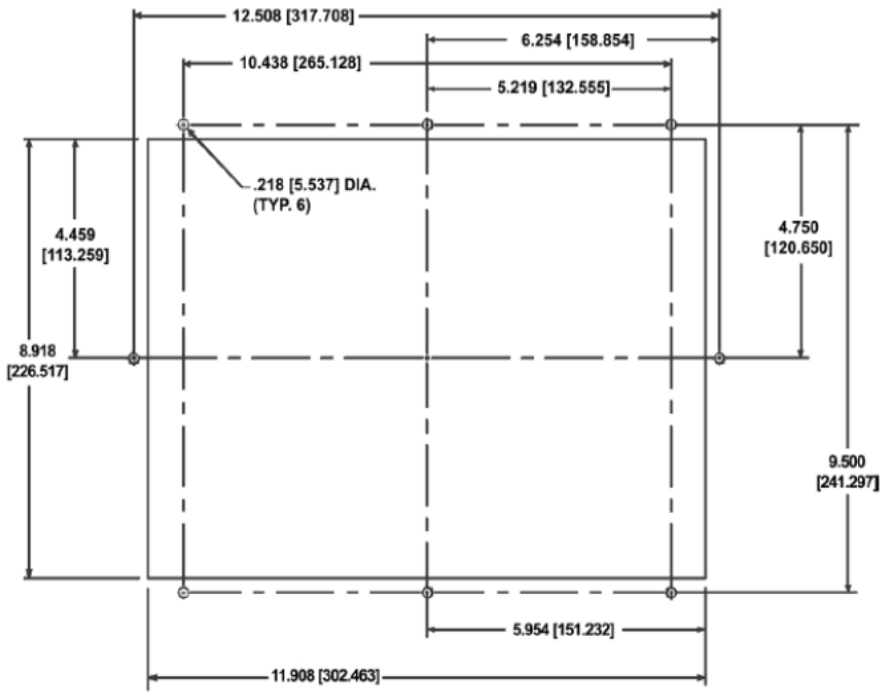

6 Wiring

6.1 Ports and Communications

3-Terminal Power Connector

Power: 24 VDC	
1	Positive
2	Negative
3	Earth GND

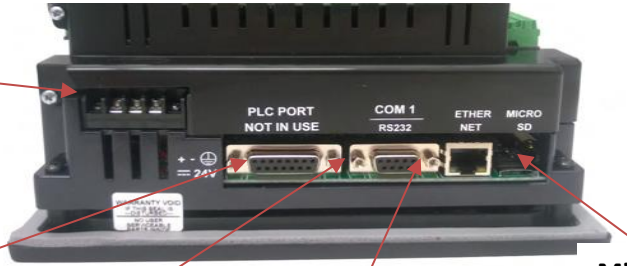

Micro SD card Connector

15 Pin D-Sub Serial RS232/422/485 PLC Port
Reserved Port, Do not use!

9 Pin D-Sub Serial Programming Port

RJ45-Ethernet connector

PGMCBL: Programming Cable Wiring

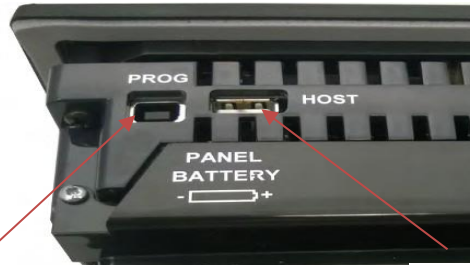
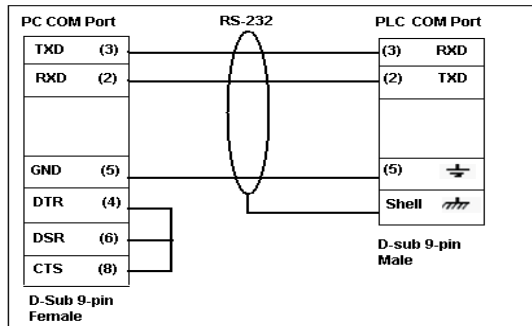

USB Type B for Programming

USB Type A for flash drives

Indicator Light at the backside of the unit	
Flashes Red, then continuously Green	Power connected, Normal Operation
Blinking Red / Continuously Red	Some Panel Issue has occurred. Please try a power cycle, if that does not fix the issue please contact Tech Support.
No Light	Power source not connected or inadequate

6.2 Nano PLC - I/O

6.2.1 Connection for I/O

The EZTouchPLC comes with Easy to Wire Phoenix Terminals.

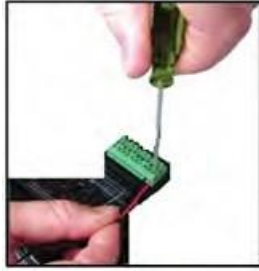

As shown in the picture, simply insert the wire and screw to tighten. You can wire up to ONE 14 AWG wire, TWO 18 AWG wires, or FOUR 22 AWG wires in every terminal. You will need a 2.5mm blade screwdriver (P/N **EZIO-SCDRV**) to work with the I/O terminals and wiring.

Wires Supported

UL rated at 300 volts, 10 amps 14 AWG

Number of Wires Allowed in Each Terminal	
1	14 AWG
2	18 AWG
4	22 AWG

6.2.2 Terminal Layout

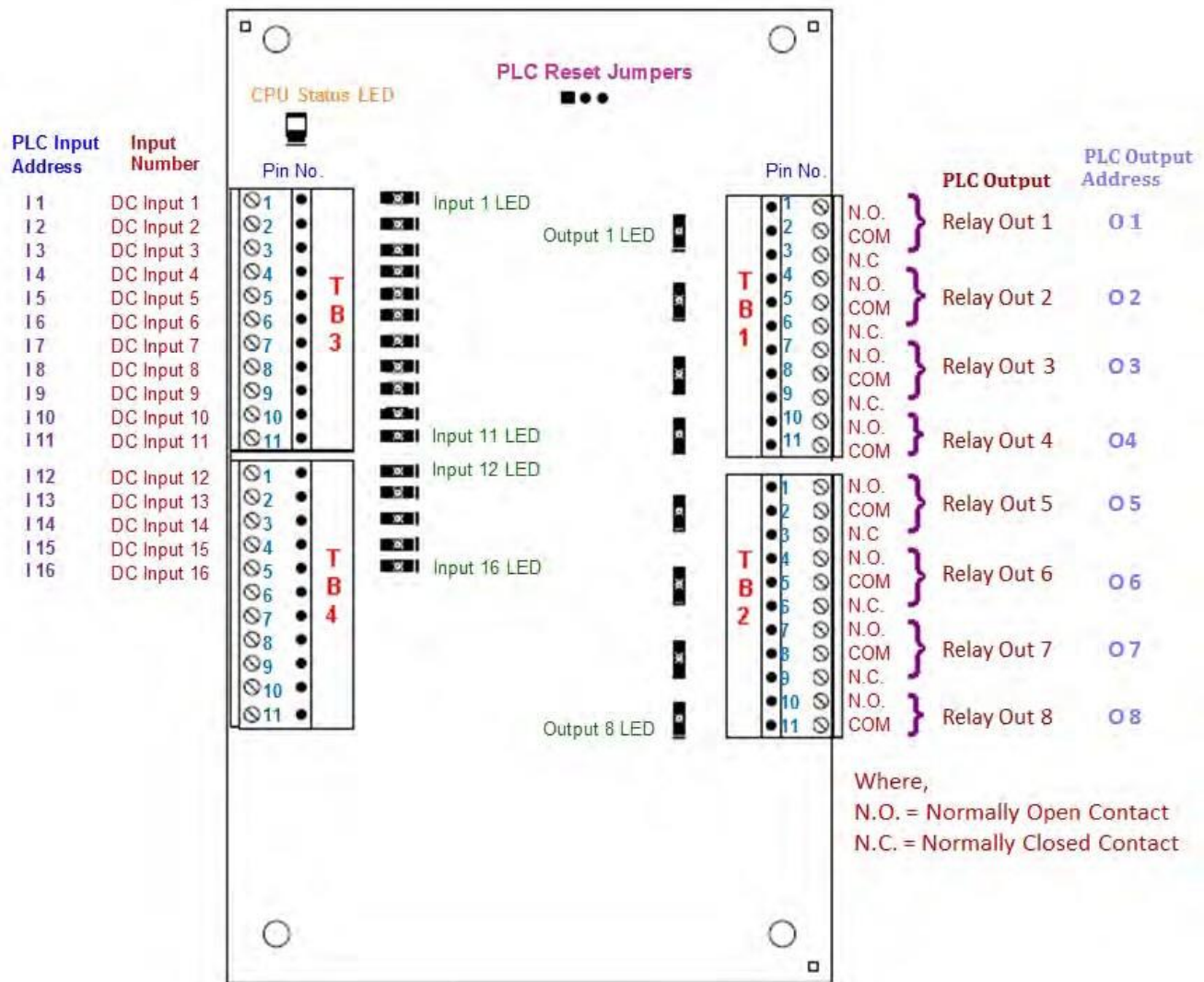

6.2.3 Terminal Pinouts

TB3 Pinout Information	
Pin No.	Pin Function
1	DC Input(1)
2	DC Input(2)
3	DC Input(3)
4	DC Input(4)
5	DC Input(5)
6	DC Input(6)
7	DC Input(7)
8	DC Input(8)
9	DC Input(9)
10	DC Input(10)
11	DC Input(11)
TB4 Pinout Information	
Pin No.	Pin Function
1	DC Input(12)
2	DC Input(13)
3	DC Input(14)
4	DC Input(15)
5	DC Input(16)
6	DC Input COM
7	DC Input COM
8	--
9	--
10	--
11	--

TB1 Pinout Information	
Pin No.	Pin Function
1	Output (1)_Normally open
2	Output (1)_COM
3	Output (1)_Normally closed
4	Output (2)_Normally open
5	Output (2)_COM
6	Output (2)_Normally closed
7	Output (3)_Normally open
8	Output (3)_COM
9	Output (3)_Normally closed
10	Output (4)_Normally open
11	Output (4)_COM
TB2 Pinout Information	
Pin No.	Pin Function
1	Output (5)_Normally open
2	Output (5)_COM
3	Output (5)_Normally closed
4	Output (6)_Normally open
5	Output (6)_COM
6	Output (6)_Normally closed
7	Output (7)_Normally open
8	Output (7)_COM
9	Output (7)_Normally closed
10	Output (8)_Normally open
11	Output (8)_COM

6.2.4 Digital I/O Specifications

Digital Input Specifications	
Number of Inputs	16
Input Voltage Range	12-26 VDC
Input Current	1.92 mA @ 12 VDC 4.0 mA @ 24VDC
Maximum Input Current	4.3 mA @ 26 VDC
Input Impedance	11.5k @ 12-26 VDC
ON Voltage Level	>12 VDC
OFF Voltage Level	<2 VDC
Min. ON Current	2mA
Min. OFF Current	0.2 mA
OFF-ON Response	2-4 ms. Typical 3 ms
ON to OFF Response	2-4 ms. Typical 3 ms
Status Indicators	Red LED for each input
Commons	2 points
Fuse	No Fuse
Wires	1 of 14 AWG, 2 of 18 AWG 4 of 22 AWG

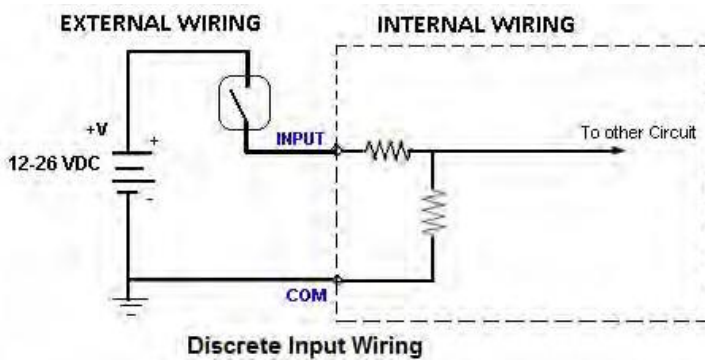

Relay Output Specifications	
Number of Outputs	8
Max Switching Voltage	277 VAC or 30 VDC
Max Switching Power	2770 VA or 300 W
Rated Switching Current	10A
Contact Resistance	100mΩ (at 1A 6VDC)
Insulation Resistance	100MΩ Min. at 500VDC
Dielectric Strength	1500VAC between Coil & Contact, for 60sec
	750VAC between Contacts for 60sec
Operate Time	Max 10ms
Release Time	Max 5ms
Status Indicators	Red LEDs

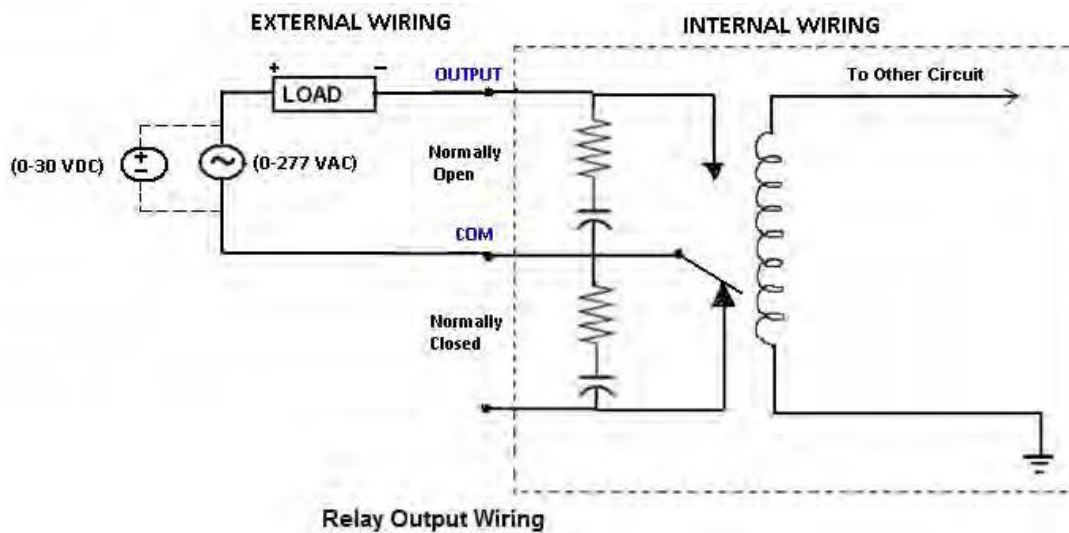

7 Programming

7.1 PLC Operation Sequence

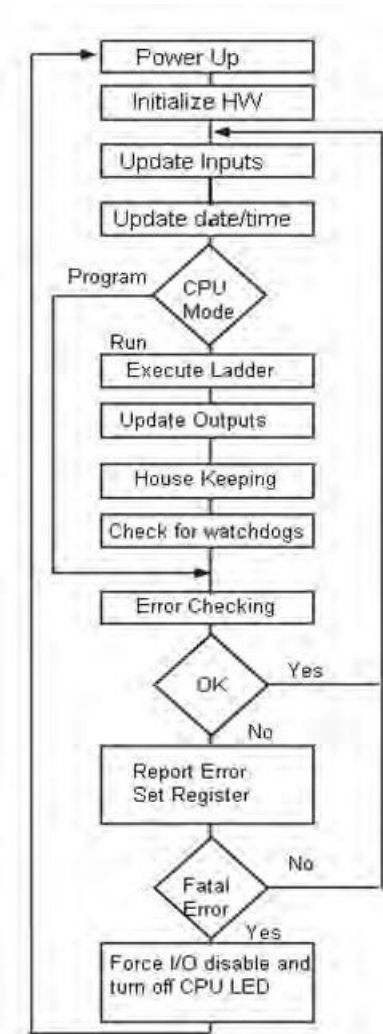

A good understanding of the EZ3-TouchPLC Nano CPU operating sequence will help you achieve the proper control for your equipment or process. The flow chart on the left shows how the CPU controls all aspects of system operation.

Power-up Initialization

On power-up, the CPU initializes the internal electronic hardware. It also checks if all the memories are intact and the system bus is operational. It sets up all the communication registers. If all registers are go, the CPU begins its cyclic scan activity as described below.

Read Inputs

The CPU reads the status of all inputs, and stores them in an image table. Image Table is EZ3-TouchPLC Nano internal storage location where it stores all the values of inputs/outputs for ONE scan while it is executing ladder logic. The CPU uses this image table data when it solves the application logic program.

Execute Logic Time

This segment is also called Ladder Scan. The CPU evaluates and executes each instruction in the logic program during the ladder scan cycle. The rungs of a ladder program are made with instructions that define the relationship between system inputs and outputs. The CPU starts scanning the first rung of the ladder program, solving the instructions from left to right. It continues, rung by rung, until it solves the last rung in the Main logic. At this point, a new image table for the outputs is updated.

Write Outputs

After the CPU has solved the entire logic program, it updates the output image table. The contents of this output image table are written to the corresponding output points.

Immediate Inputs/Outputs

There is a possibility that an input changes after the CPU has read the inputs. If you have an application that cannot wait until the CPU returns for the next input scan, you can use Immediate Instructions. These instructions do not use the status of the input from the image table to solve the application program. The Immediate Instructions immediately read the input status directly from I/O modules and update the image table with appropriate status of input module read. Similarly, Immediate Output instructions do not wait for the CPU to complete the ladder scan. Immediate outputs are directly written to the image table and Outputs are updated accordingly.

Subroutines

The CPU executes subroutines when called for in the ladder program. These subroutines are useful in performing the same logic operation time and time again just upon one call so you do not have to repeat the rung logic over and over again.

7.2 Create a Project

This section outlines the basics of creating a project using the EZSeries Editor software. Further programming information for the EZ3-TouchPLC Nano is located in the Software Manual.

Launch your Programming Software and select how you would like the program to connect to the EZ3-TouchPLC Modular Nano. For this scenario, you can select 'Open/New Project.' This will enable you to create a program without having the EZ3-TouchPLC Nano unit connected.

Note: EZ Series Editor must be version 2.2.2 or later to communicate with the EZ3-TouchPLC Nano Unit firmware must be k.5.80 or later.

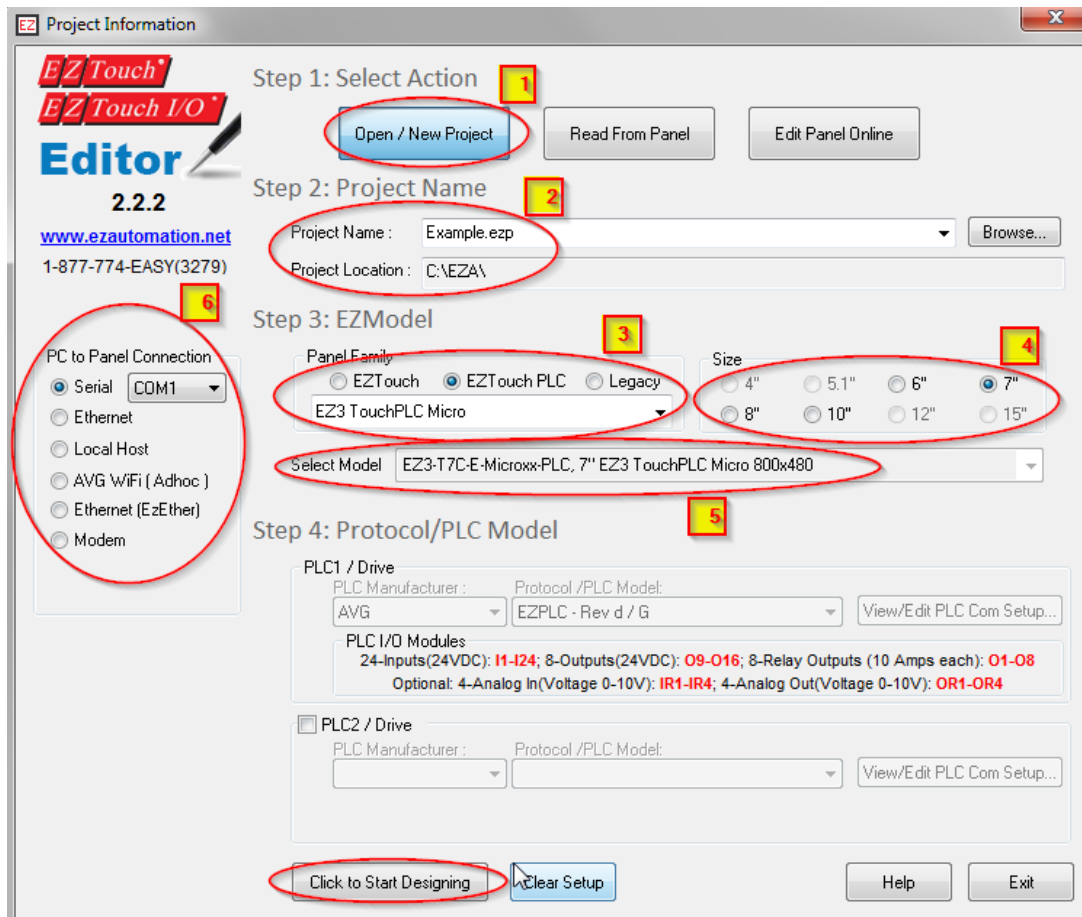

- 1 Click on Open / New Project Press ENTER. You may get a confirmation message
- 2 Enter a project name (For instance. Example.ezp) and Click OK.
- 3 Select EZModel: Panel Family – in this case EZTouchPLC, Modular, Micro, and Nano as a Unit specification
- 4 Then select the size appropriate for your purchased unit (6", 7", 8", 10" or 15").
- 5 From drop down select model (if more than one model is available, drop down would show it
- 6 Select PC to Panel Connection—Select Serial for Serial or USB connection for Ethernet, IP address must be set already (see how to set IP address later in the document)
- 7 Click OK to launch the editing software program. The Main Project Window will then appear. The steps below outline how to create a sample panel program or PLC project.

Create PLC Program: On the left side, click on "Main Logic" under the Project Tree to start creating a sample PLC Ladder Logic program as outlined below.

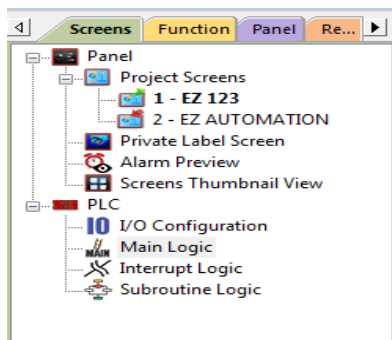

1. Select the "Relay/Boolean" type instruction set in the instruction toolbar (located on the right side of the programming screen). Click on "NO Contact."

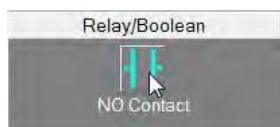

2. Click on the main ladder logic programming window to place the instruction as shown in the image below.

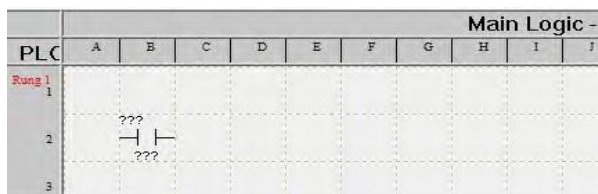

3. Then double-click on the icon and enter the tag name as "Start." Click OK.
4. A new dialog box will appear asking for the PLC address (memory location). Enter "S1" in the field to the right of "Address String." The Data Type should be marked as DISCRETE. Click OK.

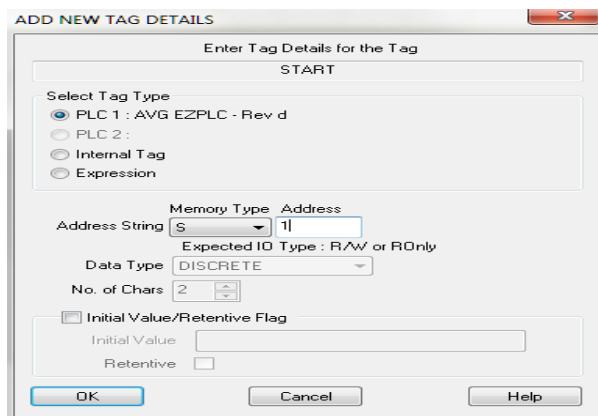

5. Similarly, click on "NO Coil" under the Relay/Boolean instructions and place the instruction in the ladder logic programming window. Double-click the icon to select the tag name as "Lamp."
6. Once again, a dialog box will appear. Enter "O1" as the address string. Click OK.

- Click on **Instructions** > **Line** to wire “NO Contact” and “NO Coil.” Your screen should look like this when finished:

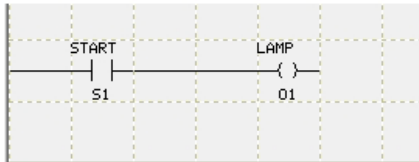

Create a Panel Program: Click on “Panel” and “Scr 1” to create the Panel display screen as explained in the sample below.

- In the Main Menu, click on **Objects** > **Buttons** > **Buttons**. The screen below will appear. Enter **START** for Tag Name. Click OK.

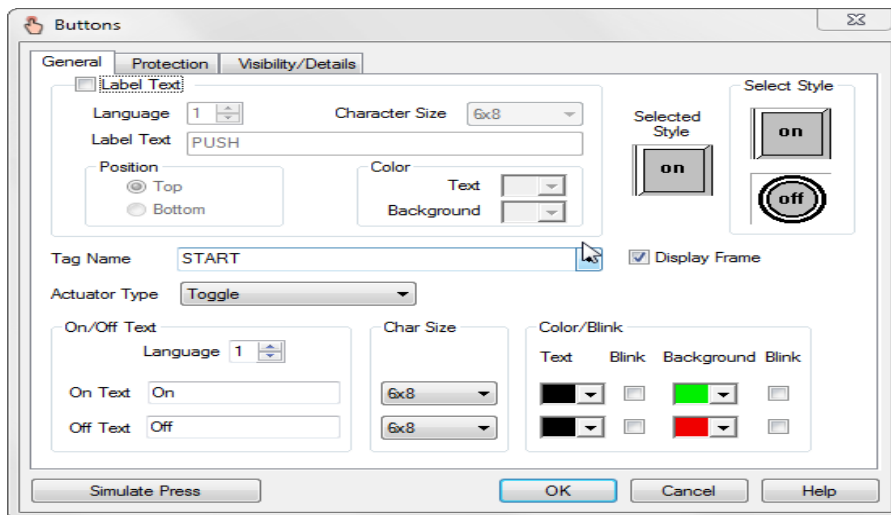

- A dialog box might appear requesting the memory location. Enter "S1" in the field to the right of "Address String." The Data Type should be marked as DISCRETE. Click OK.



- Click anywhere on the screen to place the Button object. Double click the icon to open its object dialog box if you need to adjust the object's appearance or attributes. Clicking "Simulates Press" will allow you to toggle between on and off states.

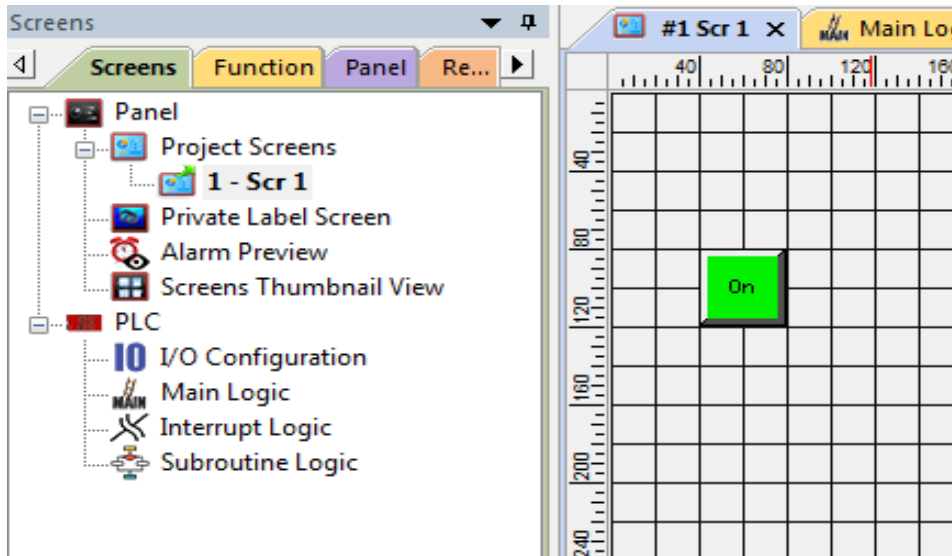

- Similarly, you can create an Indicator Light Object by selecting **Objects > Data Display > Indicator Light**. Enter **Lamp** for Tag Name. Click OK. Place the object on the panel. Your screen should look like the picture below.

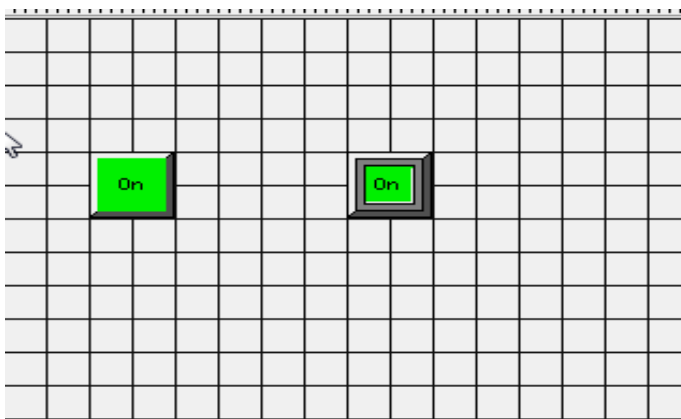

7.3 Transfer a Project

After a project is complete, the next step is to transfer the project to the EZ3-TouchPLC Nano unit. When editing projects online, programming information is automatically sent to the unit once the project is saved. When editing in an off-line mode, the project information will need to be transferred. To transfer the project through the serial connection or Ethernet port, follow the steps outlined below:

From the Project drop down menu, select **File > Transfer to Panel**. A dialog box similar to the one below will appear.

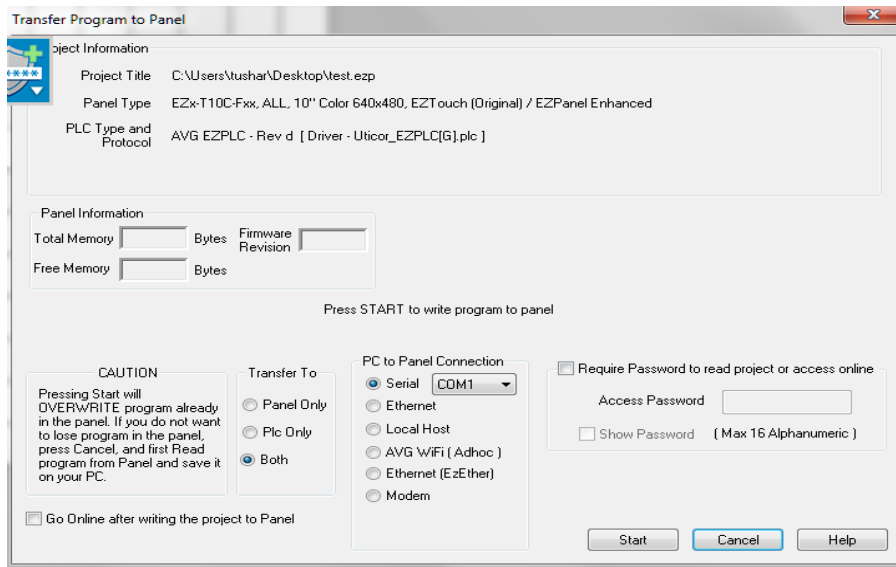

Transferring via USB programming cable:

1. Please connect your USB programming cable to the panel and your computer prior to launching the EZ Series Editor Software.
2. Under Transfer To, select both in order to transfer both the created Panel program and the PLC ladder logic project.
3. Select *Serial (COM xx)* as method of transfer under PC to Panel Connection. And then click *Start*.

Transferring via Ethernet:

1. Select Ethernet as PC to Panel Connection.
Note: Click the Specify IP/Port button in order to make adjustments to the IP Address or Port.
2. Under Transfer To, select *both* in order to transfer the created Panel program and the PLC ladder logic project.
3. Then click *Start*.

When finished, a Transfer Completed message will be displayed. Click OK to continue and the project is now transferred.

8 CPU Memory

8.1 Memory Types

A PLC system handles many numbers representing different types of information regarding processes/machine parameters. These processes/machine parameters may be anything from status of the input or output devices, timers/counters, or other data values. Before you start programming the EZ3-TouchPLC Nano, it would be helpful if you took a moment to familiarize yourself with how the system represents and stores the various types of data. Each PLC manufacturer has their own conventions for this process in their PLCs.

The [Mapping Conventions](#) section outlines the specific memory types used in the EZ3-TouchPLC Nano in greater detail. The memory types can be used to store a variety of information and can be used within various RLL instructions. See a description of each of the memory types below:

- **[Discrete Memory Type](#)**
A discrete memory type is one bit that can be either 1 or 0 (ON or OFF). Discrete memory area is used for inputs, outputs, control relays, and timer/counter bits.
- **[Word Memory Type](#)**
A word memory type is a 16-bit location that is normally used to store and manipulate numeric or ASCII data. A word memory location is also called a Register.

The following table displays all the Register/Discrete types supported by the EZ3-TouchPLC Nano along with their address range, syntax, etc.

EZ3-TouchPLC Nano Memory Map					
SYNTAX: TAAAA					
T - TYPE					
AAAA - Address of Memory Type in Decimal					
MEMORY TYPE	ADDRESS RANGE	I/O TYPE	VALUE TYPE	SYNTAX EXAMPLES	DISCRETES / REGISTERS RETAINED ON POWER CYCLE
I- Discrete Inputs	1-128	READ_ONLY	DISCRETE	I5	NONE
O- Discrete Outputs	1-128	READ_WRITE	DISCRETE	O6	O1- O32
S- Discrete Internals	1-1024	READ_WRITE	DISCRETE	S4	S1- S128
IR- Input Register	1-64	READ_ONLY	WORD	1R3	NONE
OR- Output Register	1-64	READ_WRITE	WORD	OR2	OR1 - OR64
R- Register Internals	1-8192	READ_WRITE	WORD	R100	R1 – R256
SR- System Registers	1-64	READ_WRITE	WORD	SR1	SR1 –SR64
SD- System Discrettes	1-64	READ_WRITE	DISCRETE	SD10	SD1 –SD64
XR- Index Registers	1-4	READ_WRITE	WORD	XR3	NONE
#R – Value Registers	1-4	READ_WRITE	WORD	#R4	#R1 - #R4
Note: Does not Support Access to a Bit of Word (E.g.: R100/ 0, R100/5...etc)					

Please Note: Since the PLC Editor is a common programming platform for all the models offered by the AVG PLC family, it may allow you to include 128 Inputs (I), 128 Output (O), 64 input Registers (IR) and 64 Output Registers (OR) in the main logic. However, the TouchPLC Micro only physically supports 24 discrete inputs and 16 discrete outputs; hence it is recommended that you only use I1-I24 and O1-O16 while programming the Micro. Similarly, the TouchPLC Nano only physically supports 16 inputs and 8 outputs; hence it is recommended that you only use I1-I16 and O1-O8 while programming the Nano. The remaining O bits may be used as "Scratch bits." Similarly, only IR1-IR4 and OR1-OR4 should be used to address the I/O Registers, while the rest of the Output Registers may be used as "Scratch Registers." Although there are 64 System Registers (SR) and 64 System Discrete (SD) available in the programming software, many of them are preassigned a function.

8.2 Mapping Conventions

Discrete Inputs/Outputs

Discrete Inputs

Discrete Inputs are denoted using an "I" pre-fix (e.g. I1, I4, etc.). The maximum number of physical Inputs available in an EZ3-TouchPLC Nano is 24. Hence, you may only use I1 – I24 in your main logic.

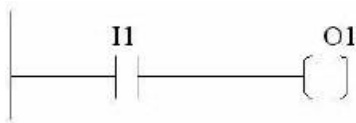

Note: All the discrete type EZ3 Inputs are mapped to Discrete Input bits. In the example above, the output bit O1 will be turned on when input I1 allows power through the rung.

Discrete Outputs

Discrete Outputs are denoted using an "O" pre-fix (e.g. O1, O4, etc.). The maximum number of programmable Outputs available is 1 through 128. Discrete Outputs are Read-Write type.

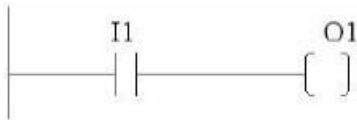

Note: All the discrete type EZ3 Outputs are mapped to Discrete Outputs bits.

Word Inputs/Outputs

Input Register (Word)

Input Registers are denoted using an "IR" pre-fix (e.g. IR1, IR4, etc.). These are 16-bit Word data types (registers). The maximum number of Input Registers available is 1 through 64.

Note: All the EZ3 Analog Inputs (if available) are mapped to Input Registers.

Output Register (Word)

Output Registers are denoted using an "OR" pre-fix (e.g. OR1, OR4, etc.). These are 16-bit Word data types. The maximum number of Output Registers available is 1 through 64.

Note: All the EZ3 Analog Outputs (if available) are mapped to Output Registers.

Internals

Discrete Internals (Discrete)

Discrete Internals are denoted using “S” pre-fix (e.g. S1, S4, etc.). There are 1024 Discrete Internals available in the EZ3-TouchPLC Nano. Internals are Read-write type and are used as “Scratch bits”. Discrete internal bits are mainly used to control the user logic program. They do not represent a real physical device, like a switch, output coil, etc. They are only internal to the CPU. You cannot program discrete internals as discrete inputs or discrete outputs for the physical inputs or outputs.

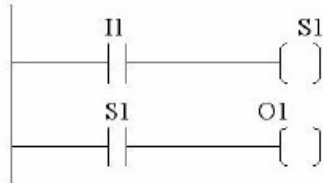

Note: In this example, memory location S1 will be powered when input I1 turns on; you can then use a discrete internal as an input in another rung.

Register Internals (Word)

Internal Registers are denoted using an “R” pre-fix (e.g. R1, R4, etc.). These are 16- bit Word data types (registers). There are 8192 Internal Registers available in the EZ3-TouchPLC Nano. "R" are Read-Write type of data registers.

System

System Discretes (Discrete)

System Discretes are denoted using an “SD” prefix (e.g. SD1, SD4, etc.). SDs are discrete memory locations with pre-assigned functionality. There are many different types of System Discretes. They are used to help in logic program development, provide system operating status info and more.

Note: Many System Discretes are preassigned a function.

System Registers (Word)

System Registers are denoted using an “SR” prefix (e.g. SR1, SR4, etc.). These are 16- bit Word data types (registers). System registers are Read-Write type data points.

Note: Many System Registers are preassigned a function.

Index and Value Registers (Word)

The Index Register data type is represented by an “XR” prefix (e.g. XR1, XR2 etc.). There are 4 XR memory locations available in EZ3-TouchPLC Nano. “XR” is a Read- Write data type and it is mainly used to point to the correct address of “R” registers. The pointed-to “R” registers data value is stored in “#R” registers.

Value Register data type is represented by a “#R” prefix (e.g. #R1, #R2 etc.). There are 4 #R memory locations available in EZ3-TouchPLC Nano. “#R” is a Read-Write data type and it is mainly used to read/write value of “R” registers as pointed out by “XR” registers.

Both XR and #R registers are used in conjunction with each other and provide a convenient way of addressing R registers.

Example:

Let's assume data values: R59=9874, R8000=32 If XR1=59

Then #R1=9874 (the actual data value of R59) If XR2=8000

Then #R2=32 (the actual data value of R8000)

XR contains the address of the operand (or specifies a register that contains the effective address), #R is used to read or write the actual operand. Indirect addressing is often combined with pre- or post-increment (or decrement) addressing. This allows the address of the operand to be increased or decreased by the specified number either before or after using it. Proper usage of XR variables often saves a lot of programming.

9 Additional Features

9.1 Data Logging Overview

The EZ3-TouchPLC Nano offers a flexible Data Acquisition capability. You can acquire and save the data for one or more tags defined in the panel. The acquired data along with a time stamp is saved in CSV file format in the USB stick or the MicroSD card, depending on how the schedule is set.

Schedules determine the way data will be collected. For example, data can be collected every 10 seconds, or simply at a specific time such as 9 AM, or when a certain event takes place. The user can define one or more schedules as long as each schedule is unique. (For example, there cannot be two schedules that each collect data every 30 seconds.) User can also associate a name (up to 8 characters) with each schedule. Each schedule can be used to collect data for up to 32 tags.

Adding a Schedule

1. Open your project file for the EZ3-TouchPLC Nano using the EZ Series Software.
2. Then click **Setup** → **Data Acquisition** to display the DAQ schedule dialog.

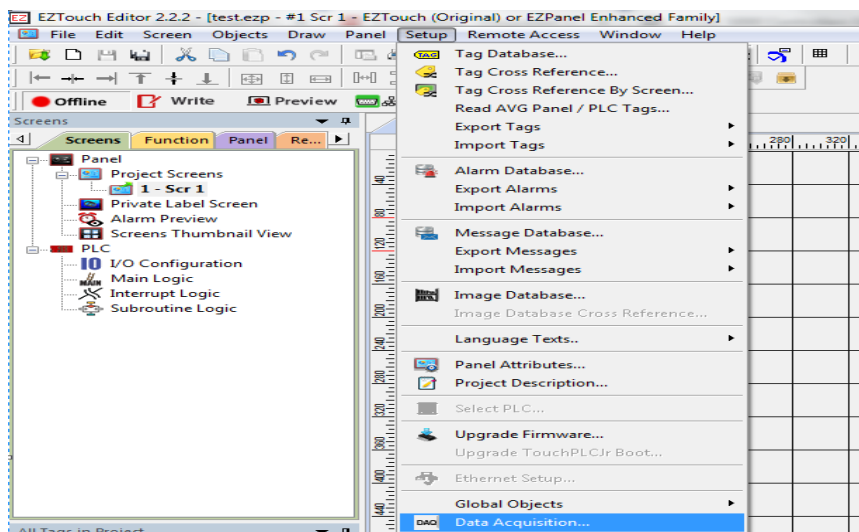

3. The Data Acquisition dialog box will appear. This dialog box allows you to add the new schedules and edit/delete the existing ones.

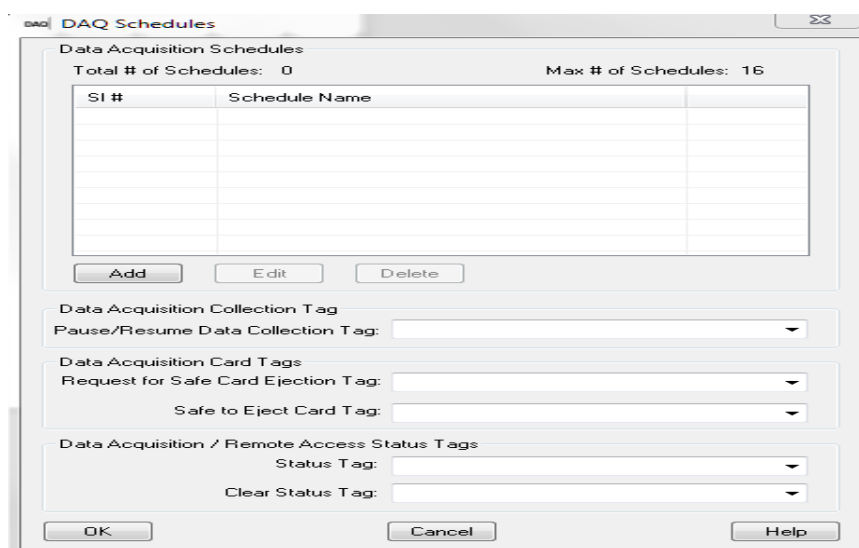

4. Click on Add button to display the "Add/Edit Schedule Details."

Add/Edit

5. The "Add DAQ Schedule Details" box will appear allowing you create a new schedule for the panel. Schedule names can be either be Tag based or a Constant (user defined name).

Note: Tag based file names can be changed on the panel itself at any point.

6. Select a Schedule Type. (Details on schedule types provided below.)

7. Under "Select Tags for Data Acquisition," the selection displays all the tags defined in the panel with their corresponding tag addresses. To select a tag for data acquisition, click on it and then press the >> button. To deselect the tag for data acquisition, select it again and press the << button. Maximum tags per schedule is 32.

Note: Tags can also be selected or deselected by double-clicking on them.

8. Click "Add" when finished and then click "Close" to return to the main DAQ Schedules dialog box.

9. The added schedules will now be listed. Schedules are saved along with the user project.

Types of Schedules

1. Time based – at regular Intervals

Allows you to store the tag value at regular time intervals, anywhere from every 1 second to every 1000 hours.

2. Time based – at Specific Times

Allows you to store the value of a group of tags up to 10 specific times. You may always edit / delete a specified time.

Collection Time
06:00:00

3. Event Based:

Allows you to create an event and store the values of a group of tags on the occurrence of the same. Based on the data type of the event tag, schedule can be either Discrete Event Type or Numeric Event Type.

Discrete Type Event:

Numeric Type event:

4. Event Based - at Regular Intervals:

Allows you to create an event and store the values of a group of tags on the occurrence of the same during a set time period. Based on the data type of the event tag, schedule can be either Discrete Event Type or Numeric Event Type.

- a. Set how frequently the data is stored through the Time Based interval, anywhere from every 1 second to every 1000 hours.

b. Select either a Discrete Type Event or a Numeric Event Type.

Discrete Type Event:

Numeric Type event:

Pausing Data Acquisition and Ejecting Card

Pause / Resume Data Collection Tag:

This is a discrete tag that can be controlled by user (e.g. through a Push Button) or by PLC to enable or disable data acquisition. When the tag's value is 0, data collection is enabled; and when it is 1, the collection is disabled or

paused. Setting the tag to 0 resumes the data collection.

Request for Safe Card Ejection Tag:

This is a discrete tag and can be controlled by user or PLC. The Tag is set by user (say by a Pushbutton) or by PLC to indicate that the user would like to remove the SD card for possibly reading it in a SD card reader. When Panel sees this tag as set, all buffered data is written to the files, and files are closed for safe removal of the card. Another discrete tag, Safe-to-Eject-Card is set to indicate that it is now safe to remove the SD card without fear of file corruption. At the same time, the Request tag is reset by the panel.

Safe to Eject Card Tag:

This is a discrete internal tag. The tag must not be mapped to PLC. The Panel would set this tag when it is safe to remove the card. It is reset whenever it is unsafe to remove the card. **It is highly recommended that you use Request-for-Safe-Card- Ejection and Safe-to-Eject-Card tags for removing the card. If the card is removed without safe indication, the data on the card may get corrupted due to open files.**

Changing logging between USB and Micro SD

There are two options to change how the data logging information is saved.

Option #1 Using the Programming Software

1. Open your project file for the EZ3-TouchPLC Nano using the EZTouch Editor Software.
2. Then click **Setup > Data Acquisition** to display the DAQ Schedule dialog.
3. Select either USB Flash Drive or MicroSD card.
4. Click OK and then save the project.

Option #2 on the EZ3-TouchPLC Nano

1. Press the upper left corner of the EZ3-TouchPLC Nano screen for a minimum of six seconds to access the Setup Mode.
2. After selecting the appropriate language for the unit, the unit will enter the Setup Mode (shown below).

Press the "LogToSD" button to change how the data is logged.

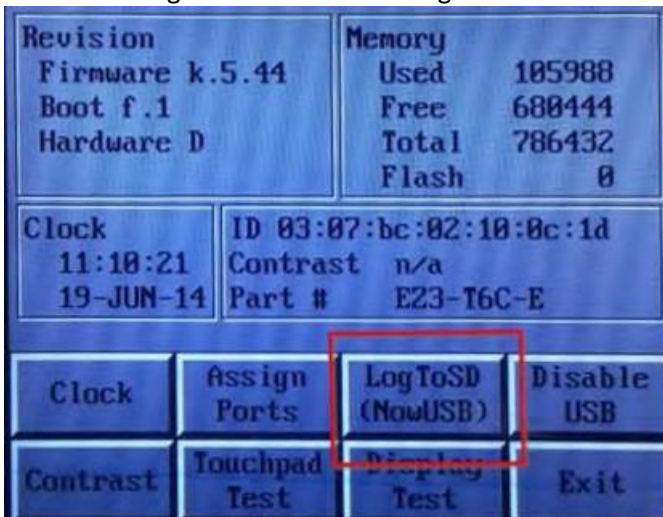

3. When finished, press Exit to resume normal operations.

9.2 Create OEM Packager

The **EZ3 Packager utility** allows an OEM to distribute updates to EZ3Touch or EZ3PLC projects easily and quickly. Using the utility, OEMs can package current project and/or firmware into a zip file for distribution to the end user via email or the web. If you click on **File > Create OEM Package**, it will allow you to package the current **EZ3 Panel** or **EZ3 PLC project** and/or the **firmware** into a zip file called a **pack file** for the distribution purposes. **Benefits of the utility include:**

- OEMs save costs associated with the distribution of panel updates in the field (sending field service personnel or mailing CDs).
- OEM Projects are protected since end users cannot modify the projects.
- The end user benefits from convenient, fast and easy updates without needing to purchase the EZTouch Editor software.

Creating a Pack File:

1. Use the EZ Series Editor Software to open the project you wish to distribute.
2. Click on **File > Create OEM Package**. A dialog box similar to the one shown below will appear. Select what firmware you wish to include in the zip file. (Use Browse to locate the latest firmware versions if necessary.) Enter any necessary OEM information you wish to include in the fields provided.

"Create OEM Package" allows OEMs to distribute new or upgraded projects very easily. This would create a zip file containing project, update utility and optionally firmware upgrade.

Include Firmware Upgrade For Panel
Panel Firmware File Name: Touchpanel_EZ12_L2_17.hex [Browse]

Include Firmware Upgrade For PLC
PLC Firmware File Name: [Browse]

Make sure to include the right firmware file, otherwise the project may not work properly

Display following OEM information during Upgrade

Company Name: AVG Machine/Model: xx.xxx.xxx

Message: xyz.....

CAUTION: abc.....

Web Site: www.EZAutomation.net Support Phone Number: []

Support Email: techsupport@ezautomation.net 1877743279

Save OEM Package File as: Example_Backup.ezp [Browse]

[Help] [Cancel] [OK]

3. Use Browse to determine the file save location and OEM package name. Then click

Save OEM Package File as: test_OEM Package.zip [Browse]

Opening a Pack File:

A Pack File contains the following:

1. Updater application (comprising of the .exe and required dlls)
2. Project files (which would show up inside the Project folder when unzipped)
3. Firmware files (which would show up inside the Firmware folder when unzipped)

The end user can take the pack file, unzip it, and then run the EZTouch I/O Updater application to update his/her panel with the selected project(s) and/or firmware. To open a pack file, follow the steps below:

1. Click on the zipped OEM Package file that you have. It contains EzUpdate.exe (Ezupdater MFC application) and example.pkg (PKG File). Extract these file in a folder of your choice.

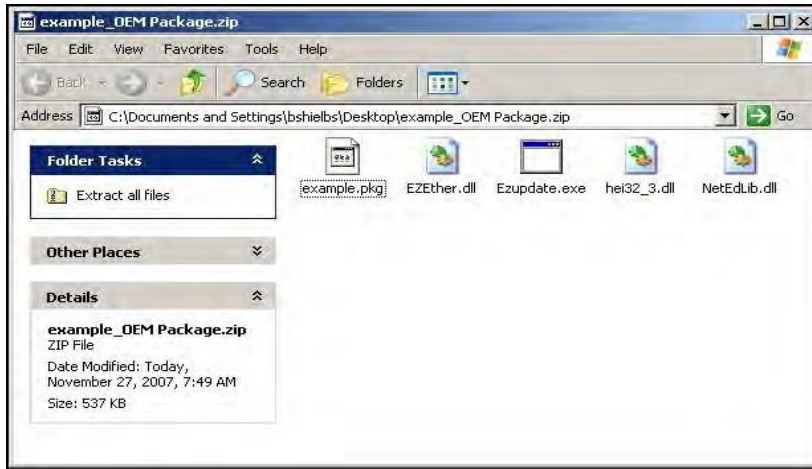

2. In this example, files have been extracted in a folder named as **example_OEM Package**.



3. Click on the **EzUpdate** utility for the following dialog window. Browse and select the **Package File** to be used for **updating the project and/or firmware**. Then click **OK**.

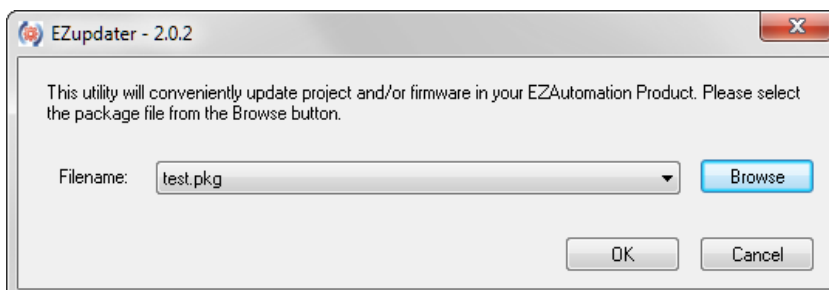

- Once you click on **OK**, EZUpdater window appears on the screen with an option to select the communication port. You may also test the connection, before a final click to update button. Click on the **Update** button to update the Project and/or the Firmware on your EZ Series TouchPLC.

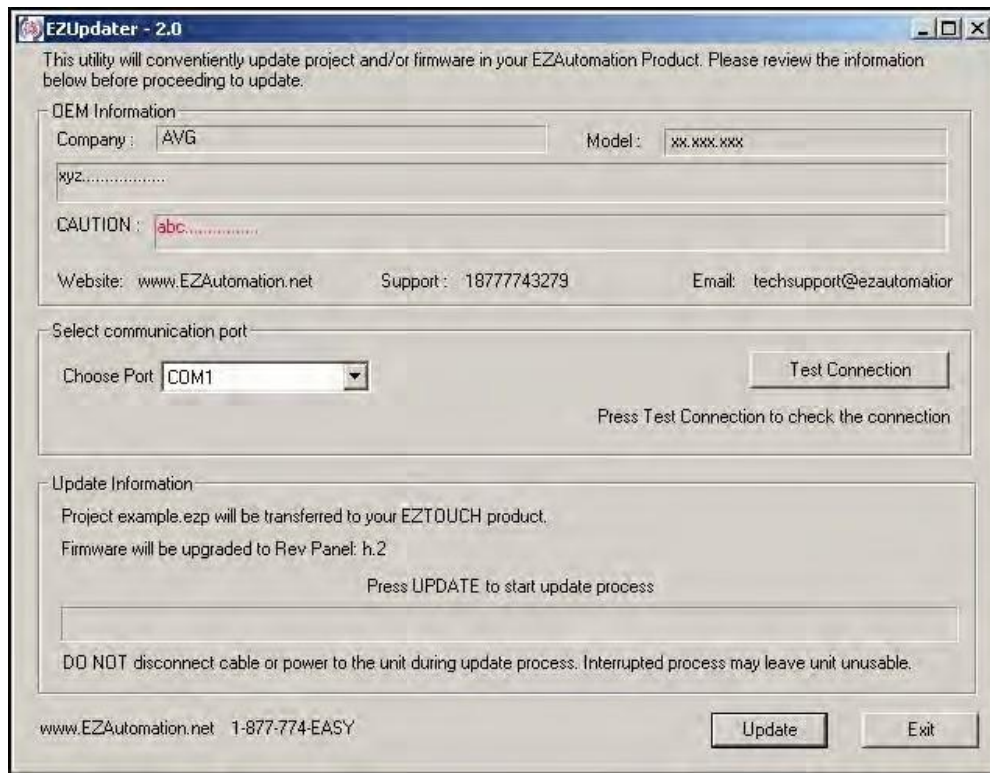

9.3 Create USB Loader

Through the EZTouch Editor Software (version 5.5 and higher) users can program EZ3-TouchPLC Nano through a USB Flash drive. This process especially benefits System Integrators and OEMs with upgrading the Panels on-site without having to actually connect to a computer. Since multiple programs can be saved on one USB Flash drive, the user can program different panels with the same USB Flash drive, or quickly change the Panel for different jobs.

The EZ3-TouchPLC Nano can be programmed in following easy steps:

1. Create a USB file (*.hmi) using the EZTouch Editor.
2. Save the file on the USB Flash drive (only in the root directory).
3. Insert the USB stick into the EZ3-TouchPLC Nano USB port.
4. The panel brings up a list of projects that are available on the USB Flash drive. Select the necessary project and press OK. (If the panel is not compatible with the project selected, an Error message is displayed.)
5. The project is automatically loaded on the EZ3-TouchPLC Nano.

Creating files for use with USB Flash Drive

In the EZTouch Editor's main programming window, click on menu **File > Create USB Project File** to create user project file for use with the USB flash drive. User can select name. The file is saved with .hmi extension.

The dialog box shown below would appear:

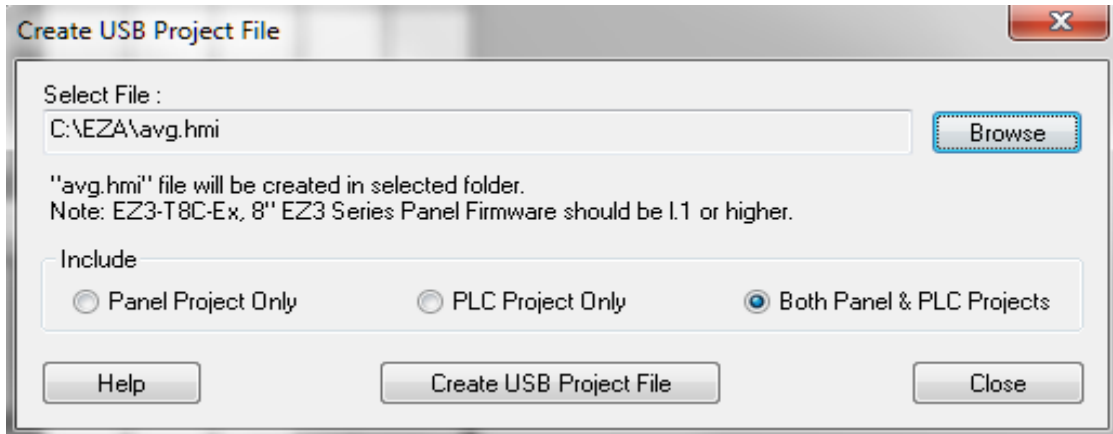

Copy file(s) on USB Drive

Copy file(s) created by the editor on the root directory of a USB flash disk. (Please note files copied in a location other than root directory would not be read by the panel.) All files are saved automatically with .hmi extension. Files without this extension will not be read.

Programming the panel using USB Drive

To program an EZ3-TouchPLC Nano from USB Drive, insert the USB flash directly into the EZTouch I/O USB port. The panel would display a list of files available in the root directory (with .hmi extension). An example is shown below:

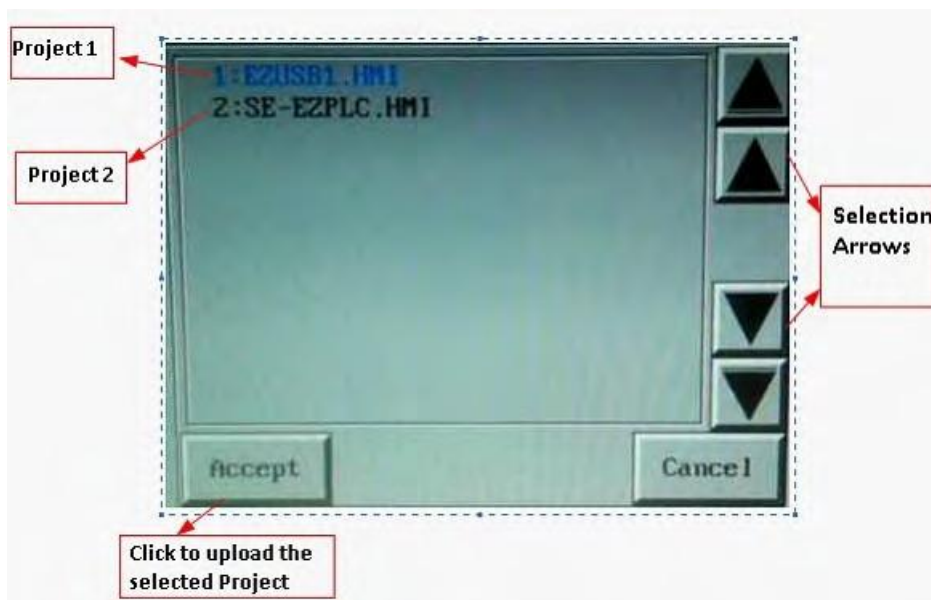

Select the required project using the Up-Down arrows and press "accept." If the panel is **not compatible** with the project selected, an Error message saying "Wrong panel Type" is displayed. The selected project is then automatically loaded into the EZ3-TouchPLC Nano.

9.4 Remote Monitoring & Control

With the introduction of new **Remote-Access Card** and **Remote Monitor & Control (RMC) Software** EZTouch I/O offer a unique set of remote capabilities. A user can remotely log on to a unit and monitor any of the panel screens with live data including the currently displayed screen.

With the right access permissions and authentication, a user can remotely “touch” the objects on the panel, to control a machine/plant effectively. Remote control feature can be invaluable for remote diagnostics, unmanned operations, or supervisory monitoring.

In addition to remote monitoring and control, user may also program the panels remotely over Ethernet, allowing OEMs to remotely upgrade the screen programs within the panels.

For Remote Monitoring and control we need to follow these steps:

1. Use EZTouch editor to set up IP address of the panel.
2. Use EZTouch editor to set up remote users and authentication level.
3. Use RMC (Remote Monitoring & Control) software to connect to the panel remotely.

Setting up Remote Users

The EZ-RMC Software can be used with or without defining authorized users. If you don't define any remote users, then anyone can connect to the panel using EZ-RMC Software. However they can **ONLY VIEW** the panel screen; they would not be able to make any changes to the panel. ***It is highly recommended that you do define authorized users for remote access.***

Remote users can be given View ONLY or Operation (View + Control) permission. View only permission allows user to ONLY monitor the panel display remotely, while operation permission allows a user to operate panel remotely.

Select **Remote Access > Remote Users** as shown below to display the following EZ- RMC User Dialog window

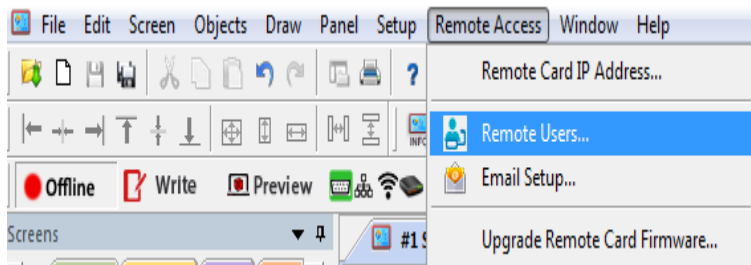

Set Remote Users

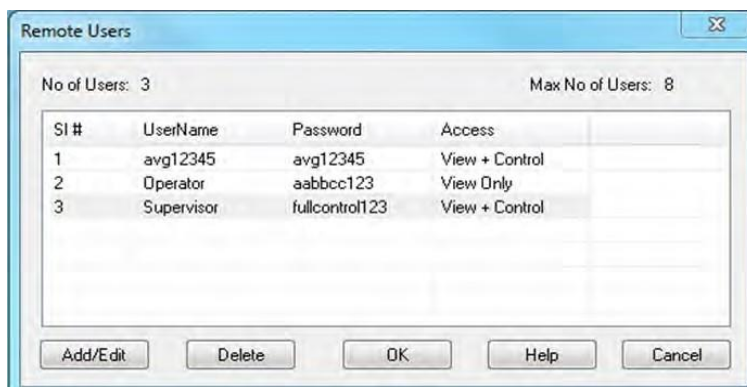

Here you may add up to 8 remote users by clicking on Add/Edit button. The Log-in name and the password are case sensitive and both must be c length. Password also must contain at least one letter and one number.

Add/Edit Remote Users

To edit the information of an existing user, please select the appropriate row and click on Add/Edit button. It will bring up the information of the selected user in edit mode.

Access Level

- **ONLY REMOTE VIEW** - A user can remotely log on to the panel and monitor any of the panel screens with live data including the currently displayed screen.
- **REMOTE OPERATION** - A user can remotely log on to the panel and monitor any of the panel screens with live data including the currently displayed screen as well as can remotely “touch” the objects on the panel, to effectively operate or control a machine/plant.

WARNING!!!

Be VERY selective and careful in allowing users remote operation access. Users MUST take extreme care during remote operation. It is highly recommended that panel/machine be watched by someone during its remote operation, as remote changes can be dangerous and can cause accident or damage to machine!!!

Run RMC Software

To access the panel over Ethernet, you need to install and run the EZ-RMC software on your PC. Once you run the software, you will see the following EZ-RMC dialog.

Select Parameters



Select the communication port, IP Address if Ethernet is selected, and Polling Time. The IP Address is the IP Address of the RMC card you setup earlier. It is recommended to keep polling time as high as possible. Polling time determines how often RMC software would read information from the panel. A lower polling time may impact the performance of the panel.

Remote User

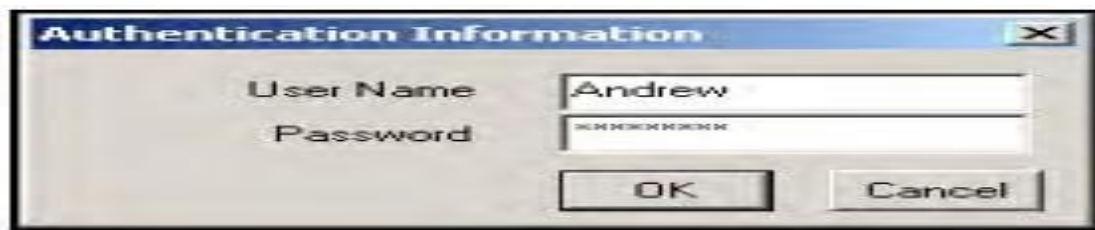

Clicking OK will prompt you to provide user name and password, if at least one remote user has been set up. **Please note that both user name and passwords are case sensitive.** If no remote users were defined, this dialog box would not appear.

Access Password

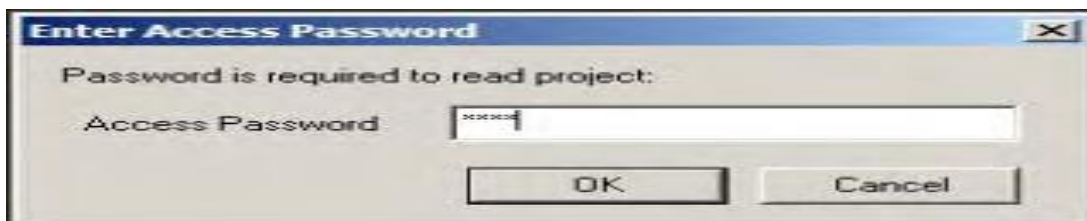

Projects requiring an Access Password will need the access password entered before the user information. You must have a correct Access Password in order to communicate with the panel. This is project level password set during screen design under **Setup > Panel Attribute > General Tab.**

10 Maintenance and Troubleshooting

10.1 Hardware Maintenance

Routine maintenance checks should be performed on the unit to avoid any risk of hardware problems. The EZ3-TouchPLC Nano is designed to be a very rugged controller so that just a few checks periodically will help keep it up and running.

The key points to be checked include:

- Ambient operating conditions
- Wiring and connections

Maintaining the Ambient Operating Conditions

Keeping the EZ3-TouchPLC Nano unit's environment within specified operating conditions is the best method to minimize the maintenance.

1. Always ensure that ambient temperature inside the cabinet is within EZ3-TouchPLC Nano unit's temperature ratings.
2. If any other equipment inside or outside of the cabinet is producing heat, employ cooling methods like a blower fan to reduce 'hot spots' around the EZ3-TouchPLC Nano.
3. Periodically inspect and clean if there are any air filters on the cabinet. Ensure that the unit is free from dust, humidity and corrosive gases.

Error Checking Process

The EZ3-TouchPLC Nano performs a standard diagnostic routine during each CPU scan. This is called the error-checking step. The primary task of this step is to identify various types of CPU and I/O failures. We classify these errors/failures broadly into two categories: Fatal and Non-Fatal.

Fatal Errors

These errors are the ones that lead to the system failure. During the CPU scan if a fatal error is detected, PLC is automatically switched out of Run mode and all I/O points are disabled. Some instances of fatal errors include: Wrong parity value, Programming errors, etc. The EZ3-TouchPLC Nano will not go into Run Mode from Program if it detects a fatal error.

Non-Fatal Errors

These errors just need your attention and are not detrimental to PLC operation. Unlike fatal errors, the PLC will continue in Run mode despite an occurrence of non-fatal errors. When you identify such errors, you can proceed with an orderly shutdown and take the required corrective action. An example of non-fatal error is – a minor programming error.

10.2 Changing the Battery

The unit comes with a built in Lithium battery with a 5 year life expectancy. The steps below outline the process to change the battery inside the unit. Since only the information saved to the registers/discretes available on a power cycle will remain intact, please save pertinent information before attempting to change the battery. Then remove power from the unit.

1. Open the back cover to access the battery.



2. The battery is located in the upper-left hand corner as shown in the figure below. Remove the old battery and replace with a new 1/2 AA, 3.6 V Lithium Battery (Part Number: **EZ-BAT**).



3. Close rear cover and ensure that the door latches.
4. Reconnect power source. Connect to PC and run the Programming Software to transfer back the user program to the EZ3-TouchPLC Nano.

The Real Time Clock (RTC) will need reset after the battery has been replaced. All information saved to the registers/discretes available on a power cycle will remain intact. Data not saved to registers/discretes available during a power cycle will be lost.

10.3 Update Firmware

There are several methods to update the firmware for an EZ3-TouchPLC Nano unit. Previously, it was explained how to update firmware through an OEM Packager file. Alternatively, the user can follow the steps below to update firmware through the EZ Series Software and a COM port on the EZ3-TouchPLC Nano unit.

Note: A firmware upgrade will wipe out the existing project in the unit; it is always advised to take a backup of the project before firmware upgrade process.

1. Insert the EZ-PGMCBL programming cable into the COM1 port. Then launch the EZ Panel Editor software.
2. Select Edit Program OFFLINE and enter a project name (e.g. Test). Click OK.

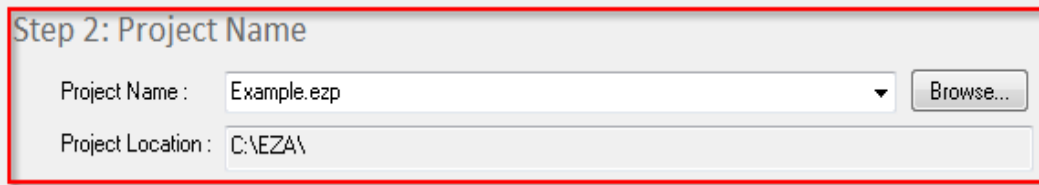

Step 2: Project Name

Project Name : Example.ezp

Project Location : C:\EZA\

3. Under Panel Family, select EZ3 Series. Then select the size appropriate for your purchased unit (6", 7", 8" or 10").

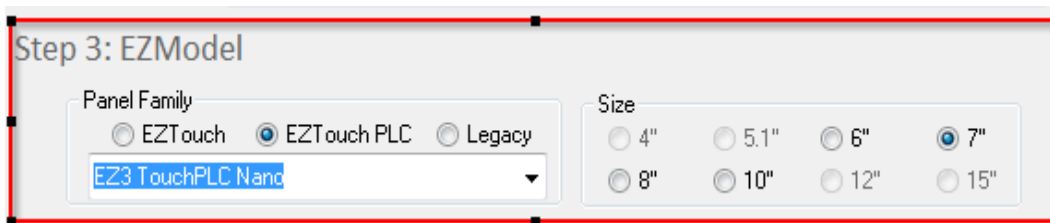

Step 3: EZModel

Panel Family

EZTouch EZTouch PLC Legacy

EZ3 TouchPLC Nano

Size

4" 5.1" 6" 7"

8" 10" 12" 15"

4. After the project loads, click **Setup > Upgrade Firmware**. A dialog box will appear requesting the firmware file you would like to load to the unit.

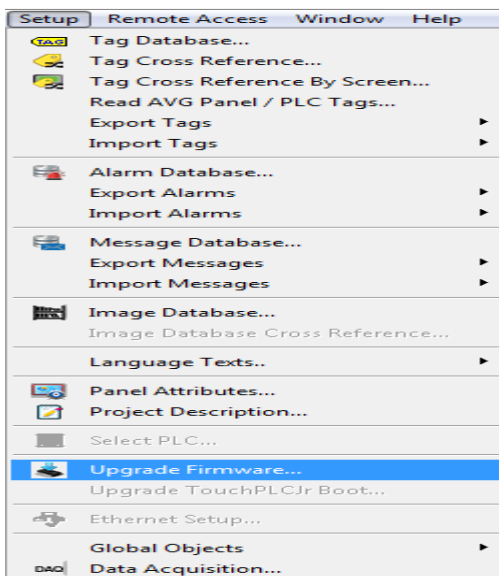

5. Use *Browse* to locate the appropriate firmware version.

Select firmware file for upgrading PLC
The PLC firmware upgrade file is usually named as PLC[_Jr]_x.x.hex_plc (x.x being the firmware version, ie. A.1). Please select PLC[_Jr]_x.x.hex_plc (or the file under which you have saved the firmware upgrade file)

C:\Program Files (x86)\EZAutomation\EZTouch Editor\Firmware\PLC_JR_C_4_82.f

Select firmware file for upgrading panel
The firmware upgrade file is usually named as Touchpanel[_Jr]_x.x.hex (x.x being the firmware version, eg. H.0 and Jr for specifying TouchPanelJr Panel Firmware files). Please select Touchpanel[_Jr]_x.x.hex (or the file under which you have saved the firmware upgrade file)

Firmware Location
Firmware is generally stored under following directory:
C:\Program Files (x86)\EZAutomation\EZTouch Editor\Firmware\

6. Verify Serial (COM1) is selected under the PC to Panel Connection, then click OK.

PC to Panel Connection

Serial

Ethernet

Local Host

AVG WiFi (Adhoc)

Ethernet (EzEther)

Modem

10.4 Setup IP Address

The EZ3-TouchPLC Nano will arrive with a factory-programmed IP Address that may need edited to be compatible with your LAN network. Once the IP Address has been adjusted to the LAN, the EZ3-TouchPLC Nano can receive programming instructions through either the serial port (COM1) connection or via the Ethernet. Follow the steps below to use the editing software to update the IP Address information through a COM port on the EZ3-TouchPLC Nano.

1. Insert a USB cable or EZ-PGMCBL programming cable. Then launch the editing software EZTouch Editor.
2. Select Edit Program OFFLINE and enter a project name (e.g. Test). Click OK.

Step 2: Project Name

Project Name : Example.ezp

Project Location : C:\EZA\

3. Select EZ3 under Panel Family. Then select the size appropriate for your purchased unit (6", 7", 8", 10" or 15").

Step 3: EZModel

Panel Family
 EZTouch EZTouch PLC Legacy

EZ3 TouchPLC Nano

Size
 4" 5.1" 6" 7"
 8" 10" 12" 15"

4. Click OK to launch the editing software program.
5. The Main Project Window will then appear showing both the PLC and Panel sides to the program. To adjust the IP Address, the Panel side will need to be selected.

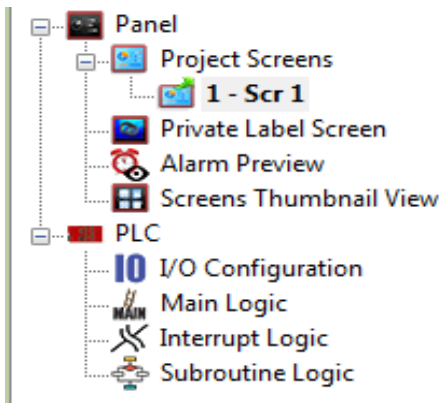

6. Click **Set-up > Ethernet Set up**. A dialog box will appear displaying the current IP parameters.

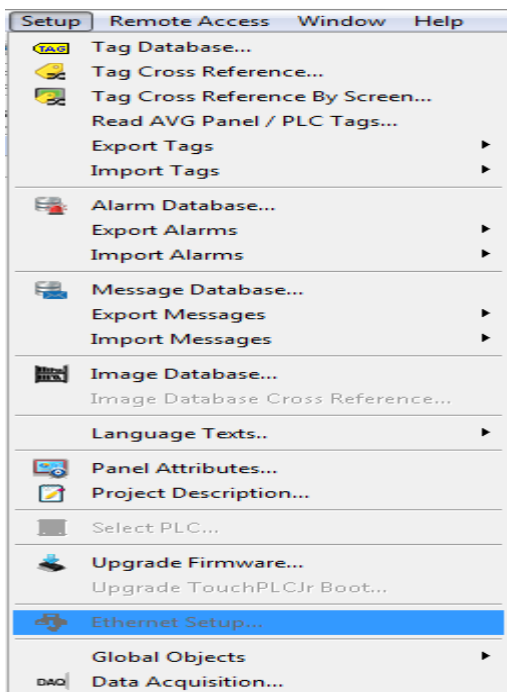

7. Once the dialog box appears, select 'Configure Ethernet Attributes.' Type in the necessary changes and click 'Set Ethernet Parameters.' Click OK.



8. Next, save the project.

10.5 Troubleshooting

If you encounter difficulties while using the EZ3-TouchPLC Nano device, please consult the list below which outlines common troubleshooting issues and their solutions. Additional assistance is also available within the **EZTouch I/O Software Help**. Alternatively, you may also find answers to your questions in the operator interface section of our website @ www.ezautomation.net.

Issue: *Panel won't power up*

Solution: *Apply power and observe the LED in the back of the panel*

- a) LED does not turn on: No power to the unit or power supply failed, check the power supply.
- b) LED turns RED and stays RED: Unit has failed, Please return the panel for repair.
- c) LED flashes RED and turns GREEN: Unit is OK, Display might have gone bad. Return panel for repair.

Issue: *Can't program the unit using USB Programming cable*

Solution: *Disconnect and then reconnect the programming cable*

Please unplug the USB programming cable from the computer and close the programming software.

Plug the USB cable back in, wait for 10 – 15 seconds and launch the Programming software.

Our programming software reads the com ports directly from the device manager of the computer and it has auto detect feature.

Issue: *USB Flash drive is not recognized*

Solution: *Using a different USB Flash drive, ensure the USB function is enabled*

Using a low memory capacity USB Flash drive, preferably less than 2 GB, press and hold the upper left corner of the Touch screen for about 6 seconds to reach the *Setup* menu on the panel. Click on *English*. Check the 2 pre-programmed buttons to ensure USB is enabled and “Log to SD (Now USB)” button is enabled. Restart / power cycle your panel.

Issue: *Touch cells not responding*

Solution: *Initiate a TouchPad Test*

Press and hold the upper left corner of the Touch screen for about 6 seconds to reach the *Setup* menu on the panel. Click on *English*. Click on the *Touchpad Test* button and press all Touch cells to see if it responds to Touch. If all buttons respond, then there is no problem with the Touch screen. If some or all of the touch cells don't respond to touch, then the unit needs to come back to the factory for repair.

Issue: *Ethernet not responding*

Solution: *Set the IP Address*

1. Please set the IP address for the panel using our programming software and going to **Setup > Ethernet Setup**.
 - a. Please match the first 3 octets of the IP address to your network and also enter subnet mask.
 - b. If your network has a gateway, then enter the gateway address.
2. Please use a straight Ethernet cable and connect it through a hub.
3. Power cycle the panel and ping the IP address assigned to the panel by going to your command prompt.
 - a. If it is pinging, disconnect the cable from the panel end and ping again, if it pings again, then there is another device with the same IP address in the network.
 - b. If it does not ping, then there is no duplicate device. Connecting the Ethernet cable back to the panel should resume communications.
4. If it is still not communicating, please restart your panel and during boot up check if the MAC ID is present. If it is not there then you will have to reset the MAC address. Please call EZ Automation Tech support for help.

Issue: *Incorrect Communication Packet (Time Out Error) Check cable and communication port*

Solution: *Check cable and communication port*

First, make sure you are using an EZ-PGMCBL. A standard RS-232 cable will not work. Next, check if the software

/ firmware incompatibility exists. Also check if you have selected the appropriate computer COM port to transfer the program in the panel programming software or see if there are any third party programs which might be using the communication port of your computer.

Issue: *Selected panel does not match the connected panel, write to panel is aborted*

Solution: *Correct panel type*

When writing/transferring the project to the panel, the panel type selected on the screen

"Step 1: Project Information" must match the panel that the computer and PLC are physically connected to or the program loader will not upload the project. Exit the OFF-LINE Editor to the "Step 1: Project Information" screen, and select the appropriate panel type and size of the connected panel and try transferring the project to the panel.

Issue: *Unable to open communication port*

Solution: *Change communication ports*

Select a different communication port in the programming software to transfer the project.

Still Need Help?

Technical Support

Most of the frequently encountered problems regarding the EZ3-TouchPLC Nano unit's operation are answered in the sections above. However, if you still need answers to your questions, please call our technical support at 1-877-774-EASY or email us at techsupport@ezautomation.net.

Warranty Repairs

If your EZ3-TouchPLC Nano is under warranty, contact us at **1-877-774-EASY**.

Out of Warranty Services

If your EZ3-TouchPLC Nano is out of warranty, contact EZ Automation at 1-877-774-EASY for an evaluation of repair costs. You can then decide whether it is more economical to proceed with the repairs or to upgrade your system with a new unit.