



# 8 pt. Analog In/4 pt. Analog Out Module (Current)

EZRack PLC

**EZRPL-IO-8ANI4ANOC**

**\$329**

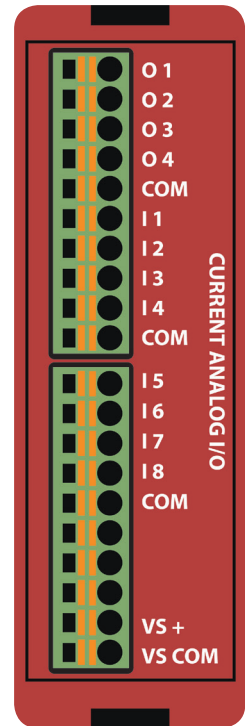

**EZRPL-IO-8ANI4ANOC**

Analog Specifications		
Analog Current Input Specs	Number of Channels	8 Single Ended
	Input Range	4-20 mA
	Resolution	12 bit (1-4096)
	Step Response	1ms for 95% FS
	Crosstalk	1/2 count max, -80db
	Input Impedance	62.5Ω ± 0.1%
	Absolute Max Ratings	-30mA to 30mA
	Converter Type	Successive Approximation
	Linearity Error (end to end)	± 2 counts
	Input Stability	± 1 count
	Full-scale Calibration Error	± 10 counts @ 20mA
	Offset Calibration Error	± 5 counts
	Max Inaccuracy	± 0.3% @ 25°C, ± 0.6% @ 60°C
	Accuracy vs. Temperature	± 50 ppm/°C typical
Recommended Fuse	.032 Amp, series 217 fast acting	
Analog Current Output Specs	Number of Channels	4 single ended
	Output Range	4-20mA
	Output Type	Current Sourcing
	Resolution	12 bit (1-4096)
	Max. Loop Voltage	6 VDC
	Load/loop	0-300Ω
	Linearity Error (end to end)	± 2 counts
	Conversion Setting Time	100µs for FS
	Full-scale Calibration Error	± 12 counts
	Offset Calibration Error	± 6 counts
	Max. Full-scale Inaccuracy (all errors included)	± 0.3%
Wires	14 to 24 AWG	

Pinout Information			
1	Output(1)	11	Input(5)
2	Output(2)	12	Input(6)
3	Output(3)	13	Input(7)
4	Output(4)	14	Input(8)
5	COM	15	COM
6	Input(1)	16	Not Connected
7	Input(2)	17	Not Connected
8	Input(3)	18	Not Connected
9	Input(4)	19	+VS
10	COM	20	VS-COM

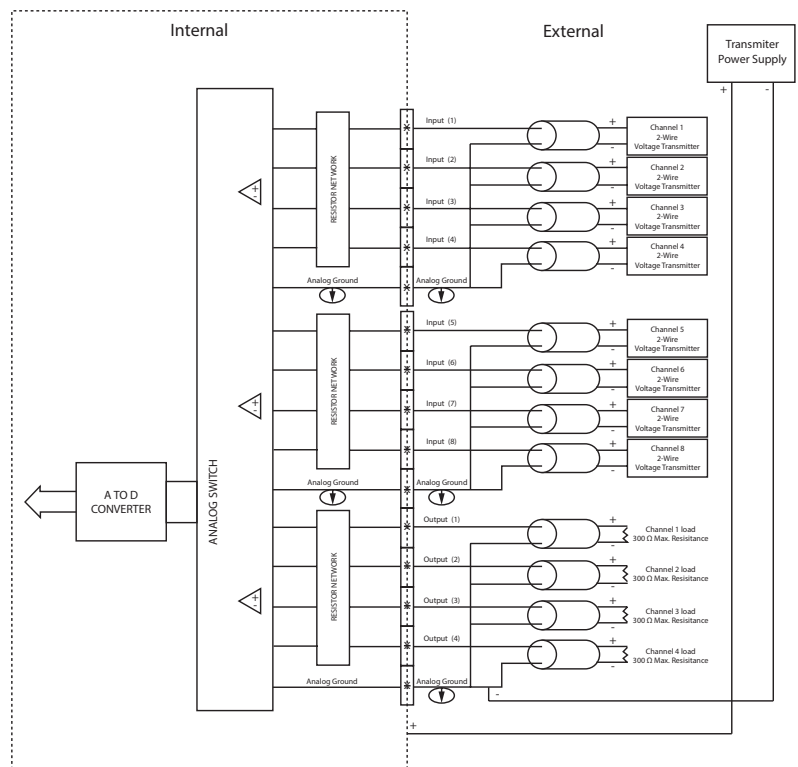

Module Specifications	
Operating Temperature	-20 °C to 60 °C
Storage Temperature	-20 °C to 70 °C
Relative Humidity	5 to 95 %
Removable Terminal Block	300 Volt/8 Amp/ 14 AWG UL Rating
Vibration	MIL STD 810C 514.2
Shock	MIL STD 810C 516.2
Noise Immunity	NEMA ICS3-304